

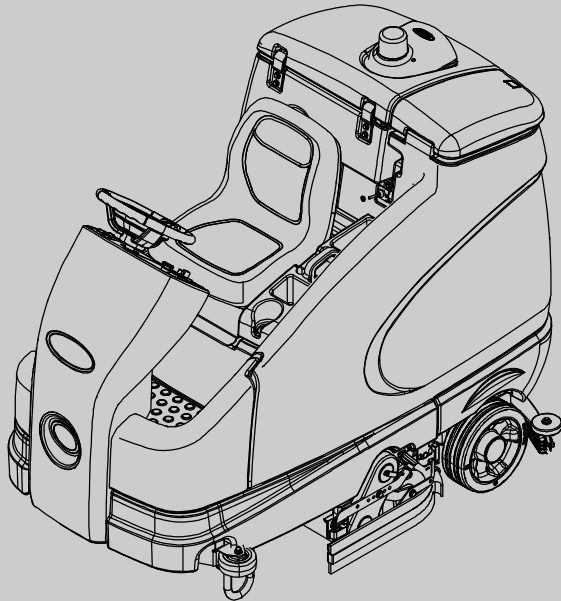

T16

(Battery)

Rider Scrubber Operator Manual



The Safe Scrubbing Alternative[®]
ES[®] Extended Scrub System
TennantTrue[®] Parts
Hygenic[®] Fully Cleanable Tanks
IRIS[™] a Tennant Technology
Insta-Fit[™] Adapter



North America / International



To view, print or download
the latest manual, visit:

www.tennantco.com/manuals

9008142
Rev. 09 (01-2018)



INTRODUCTION

This manual is furnished with each new model. It provides necessary operation and maintenance instructions.



Read this manual completely and understand the machine before operating or servicing it.

This machine will provide excellent service. However, the best results will be obtained at minimum costs if:

- The machine is operated with reasonable care.
- The machine is maintained regularly - per the machine maintenance instructions provided.
- The machine is maintained with manufacturer supplied or equivalent parts.

PROTECT THE ENVIRONMENT



Please dispose of packaging materials, used components such as batteries and fluids in an environmentally safe way according to local waste disposal regulations.



Always remember to recycle.

MACHINE DATA

Please fill out at time of installation for future reference.

Model No. – _____

Serial No. – _____

Installation Date – _____

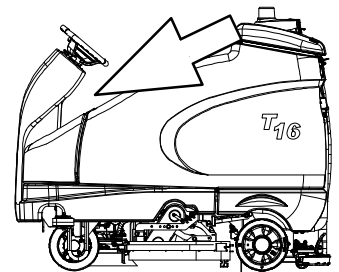

INTENDED USE

The T16 is an industrial/commercial rider machine designed to wet scrub both rough and smooth hard surfaces (concrete, tile, stone, synthetic, etc). Typical applications include schools, hospitals / health care facilities, office buildings, and retail centers. Do not use this machine on soil, grass, artificial turf, or carpeted surfaces. This machine is intended for indoor use only. This machine is not intended for use on public roadways. Do not use this machine other than described in this Operator Manual.

Tennant Company

PO Box 1452
Minneapolis, MN 55440
Phone: (800) 553-8033
www.tennantco.com

Touch-N-Go, 1-STEP, Grip-N-Go, Dura-Track, Positive Drain Control, SmartRelease, Duramer, FaST-PAK, Insta-Fit are trademarks of Tennant Company.

Flow-Rite is a registered trademark of Flow-Rite Controls.

HydroLink is a registered trademark of Trojan® Battery Company.

Specifications and parts are subject to change without notice.

Original Instructions, copyright © 2011 – 2018 TENNANT Company, Printed in U.S.A.

CONTENTS

	Page		Page
Important Safety Instructions – Save These Instructions	3	Empty The Pre-Sweep Debris Hopper	34
Operation	6	Vacuum Wand (Option)	35
Machine Components	6	Rollout Battery (Option)	37
Controls And Instruments	7	Rear Squeegee Guard (Option)	38
Touch Panel	8	Spray Nozzle (Option)	39
Symbol Definitions	9	Machine Troubleshooting	40
Installing Batteries	10	Maintenance	42
Battery Specifications	10	Maintenance Chart	43
Operation Of Controls	11	Yellow Touch Points	45
Battery Discharge Indicator	11	Lubrication	45
Hour Meter	11	Steering Chain	45
Recovery Tank Indicator	11	Steering Gear Chain	45
Solution Tank Indicator	11	Rear Squeegee Casters	45
Power Kill Switch	12	Batteries	46
Operating / Hazard Light Switch (Option)	12	Checking The Electrolyte Level	46
Seat Support Arm	12	Checking Connections / Cleaning	46
Operator Seat	13	Charging The Batteries (Off-Board Charger)	47
Deluxe Suspension Seat (Option)	13	Charging The Batteries (On-Board Charger)	48
Seat Belts	13	On-Board Battery Charger Error Codes	49
Contrast Control Button	14	On-Board Charger Settings	50
Configuration Mode Button	14	Changing The On-Board Battery Charger Fuse	51
Propel Pedal	14	Flow-Rite™ Battery Watering System (Option)	52
Brake Pedal	14	HydroLink® Battery Watering System (Option)	54
Directional Switch	14	Circuit Breakers	56
Vacuum Fan / Squeegee Button	15	Electric Motors	56
Solution On / Off Buttons	15	Scrub Brushes	57
How The Machine Works	16	Disk Brushes And Pads	57
Brush And Pad Information	17	Replacing Disk Brushes Or Pad Drivers	57
While Operating The Machine	18	Replacing Disk Scrub Pads	58
Pre-Operation Checklist	19	Cylindrical Brushes	59
Starting The Machine	20	Replacing Cylindrical Scrub Brushes	59
Filling The Solution Tank	20	Side Brush (Option)	60
Foam Scrubbing (Fast Mode) / Ec-H2o Scrubbing (Ec-H2o Mode)	20	Replacing The Side Brush	60
Conventional Scrubbing Mode	21	Pre-Sweep Brushes	61
Es (Extended Scrub) Mode	22	Replacing The Pre-Sweep Disk Brushes	61
Setting Scrub Modes	23	Replacing The Pre-Sweep Cylindrical Brush	62
Setting Brush Pressure	23	Fast System	63
Setting Solution Flow	23	Replacing The Fast-Pak Carton	63
Conventional Solution Flow	23	Cleaning The Fast Supply Hose Connector	63
Es (Extended Scrub) Solution Flow	23	Replacing The Fast Injector Filters	63
Scrubbing	24	Ec-H2o Module Flush Procedure	64
Double Scrubbing	25	Squeegee Blades	66
Water Pickup Mode (No Scrubbing)	26	Replacing (Or Rotating) The Rear Squeegee Blades	66
Stop Scrubbing	26	Leveling The Rear Squeegee	69
Draining And Cleaning The Recovery Tank	27	Adjusting The Rear Squeegee Blade Deflection	70
Draining And Cleaning The Solution Tank (Es Machines Only)	29	Replacing Or Rotating The Side Squeegee Blades	71
Turn Off The Machine	30	Replacing Or Rotating The Side Brush Squeegee Blades (Option)	72
Fault Indicator(S)	31		
Warning Codes	32		
Options	33		
Side Brush (Option)	33		
Pre-Sweep Assembly (Option)	33		

CONTENTS

	Page
Skirts And Seals	75
Pre-Sweep Side Skirts (Option)	75
Pre-Sweep Recirculation Skirt (Option)	75
Pre-Sweep Rear Skirt (Option)	75
Belts	76
Cylindrical Brush Drive Belts	76
Pre-Sweep Brush Drive Belt (Option)	76
Tires	76
Pushing, Towing, And Transporting	
The Machine	77
Pushing Or Towing The Machine	77
Transporting The Machine	77
Machine Jacking	79
Storage Information	79
Freeze Protection (Machines Without Optional Ec-H2o System)	80
Preparing The Machine For Operation (Machines Without Optional Ec-H2o System)	81
Freeze Protection (Machines With Optional Ec-H2o System)	82
Priming The Ec-H2o System	84
Specifications	85
General Machine Dimensions/Capacities	85
General Machine Performance	86
Power Type	86
Tires	86
Fast System (Option)	87
Ec-H2o System (Option)	87
Side Brush Solution Flow Rate (Option)	87
Machine Dimensions	88

IMPORTANT SAFETY INSTRUCTIONS – SAVE THESE INSTRUCTIONS

The following precautions are used throughout this manual as indicated in their description:

 **WARNING: To warn of hazards or unsafe practices that could result in severe personal injury or death.**

FOR SAFETY: To identify actions that must be followed for safe operation of equipment.

The following information signals potentially dangerous conditions to the operator. Know when these conditions can exist. Locate all safety devices on the machine. Report machine damage or faulty operation immediately.

 **WARNING: Batteries emit hydrogen gas. Explosion or fire can result. Keep sparks and open flame away. Keep covers open when charging.**

 **WARNING: Flammable materials can cause an explosion or fire. Do not use flammable materials in tank(s).**

 **WARNING: Flammable materials or reactive metals can cause an explosion or fire. Do not pick up.**

 **WARNING: Electrical Hazard**

- Disconnect Battery Cables and Charger Plug Before Servicing Machine.
- Do Not Charge Batteries with Damaged Power Supply Cord. Do Not Modify Plug.

If the charger supply cord is damaged or broken, it must be replaced by the manufacturer or its service agent or a similarly qualified person in order to avoid a hazard.

WARNING: This product contains chemicals known to the State of California to cause cancer, birth defects, or other reproductive harm.

This machine may be equipped with technology that automatically communicates over the cellular network. If this machine will be operated where cell phone use is restricted because of concerns related to equipment interference, please contact a Tennant representative for information on how to disable the cellular communication functionality.

FOR SAFETY:

1. **Do not operate machine:**
 - Unless trained and authorized.
 - Unless operator manual is read and understood.
 - Under the influence of alcohol or drugs.
 - While using a cell phone or other types of electronic devices.
 - Unless mentally and physically capable of following machine instructions.
 - With brake disabled.
 - If it is not in proper operating condition.
 - With pads or accessories not supplied or approved by Tennant. The use of other pads may impair safety.
 - In outdoor areas. This machine is for indoor use only.
 - In areas where flammable vapors/liquids or combustible dusts are present.
 - In areas that are too dark to safely see the controls or operate the machine unless operating / headlights are turned on.
 - In areas with possible falling objects unless equipped with overhead guard.
2. **Before starting machine:**
 - Check machine for fluid leaks.
 - Make sure all safety devices are in place and operate properly.
 - Check brakes and steering for proper operation.
 - Adjust seat and fasten seat belt (if equipped).

SAFETY PRECAUTIONS

3. When using machine:

- Use only as described in this manual.
- Use brakes to stop machine.
- Go slowly on inclines and slippery surfaces.
- Do not scrub on ramp inclines that exceed 7% grade or transport (GVWR) on ramp inclines that exceed 14% grade.
- Reduce speed when turning.
- Keep all parts of body inside operator station while machine is moving.
- Always be aware of surroundings while operating machine.
- Use care when reversing machine.
- Keep children and unauthorized persons away from machine.
- Do not carry passengers on any part of the machine.
- Always follow safety and traffic rules.
- Report machine damage or faulty operation immediately.
- Follow mixing, handling and disposal instructions on chemical containers.
- Follow site safety guidelines concerning backup alarms.
- Follow site safety guidelines concerning wet floors.

4. Before leaving or servicing machine:

- Stop on level surface.
- Turn off machine and remove key.

5. When servicing machine:

- All work must be done with sufficient lighting and visibility.
- Keep work area well ventilated.
- Avoid moving parts. Do not wear loose clothing, jewelry and secure long hair.
- Block machine tires before jacking machine up.
- Jack machine up at designated locations only. Support machine with jack stands.
- Use hoist or jack that will support the weight of the machine.
- Do not push or tow the machine without an operator in the seat controlling the machine.
- Do not power spray or hose off machine near electrical components.
- Disconnect battery connections and charger cord before working on
- Do not pull on battery charger cord to unplug. Grasp plug at outlet and pull.
- Do not use incompatible battery chargers as this may damage battery packs and potentially cause a fire.
- Inspect charger cord regularly for damage.

- Do not disconnect the off-board charger's DC cord from the machine receptacle when the charger is operating. Arcing may result. If the charger must be interrupted during charging, disconnect the AC power supply cord first.
- Avoid contact with battery acid.
- Keep all metal objects off batteries.
- Use a non-conductive battery removal device.
- Use a hoist and adequate assistance when lifting batteries.
- Battery installation must be done by trained personnel.
- Follow site safety guidelines concerning battery removal.
- All repairs must be performed by a trained service mechanic.
- Do not modify the machine from its original design.
- Use Tennant supplied or approved replacement parts.
- Wear personal protective equipment as needed and where recommended in this manual.



For Safety: wear hearing protection.



For Safety: wear protective gloves.



For Safety: wear eye protection.



For Safety: wear protective dust mask.

6. When loading/unloading machine onto/off truck or trailer.

- Drain tanks before loading machine.
- Lower scrub head and squeegee before tying down machine.
- Turn off machine and remove key.
- Use ramp, truck or trailer that will support the weight of the machine and operator.
- Do not load/unload on ramp inclines that exceed 19% grade.
- Use winch. Do not push the machine onto/off the truck or trailer unless the load height is 380 mm (15 in) or less from the ground.
- Block machine tires.
- Tie machine down to truck or trailer.

The safety labels appear on the machine in the locations indicated. Replace damaged labels.

WARNING LABEL – Batteries emit hydrogen gas. Explosion or fire can result. Keep sparks and open flame away. Keep covers open when charging



Located on seat panel.

WARNING LABEL – Flammable materials or reactive metals can cause explosion or fire. Do not pick up.



Located on underside of recovery tanks cover and on circuit breaker panel.

WARNING LABEL – Flammable materials can cause explosion or fire. Do not use flammable materials in tank



Located on underside of solution tank cover.

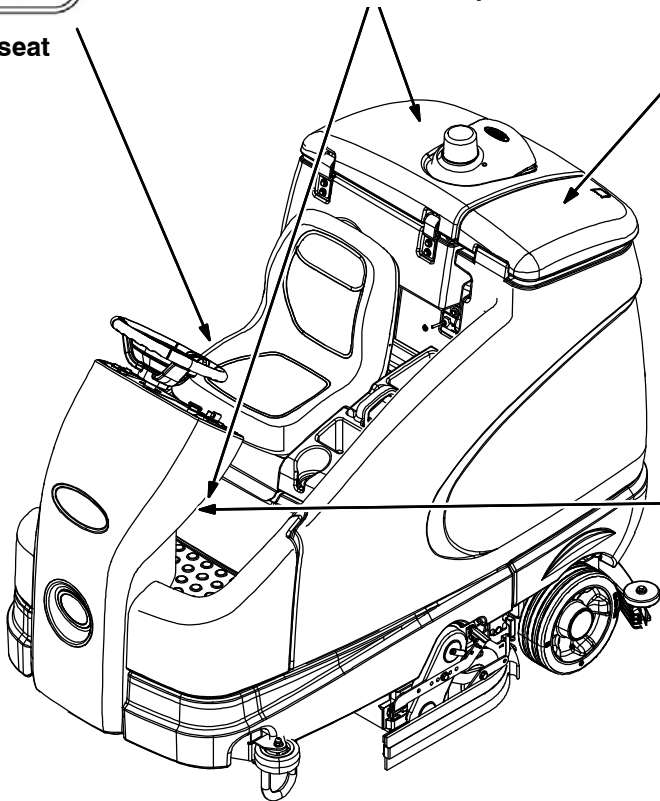

FOR SAFETY LABEL – Read manual before operating machine.



Located on circuit breaker panel.

MACHINE COMPONENTS

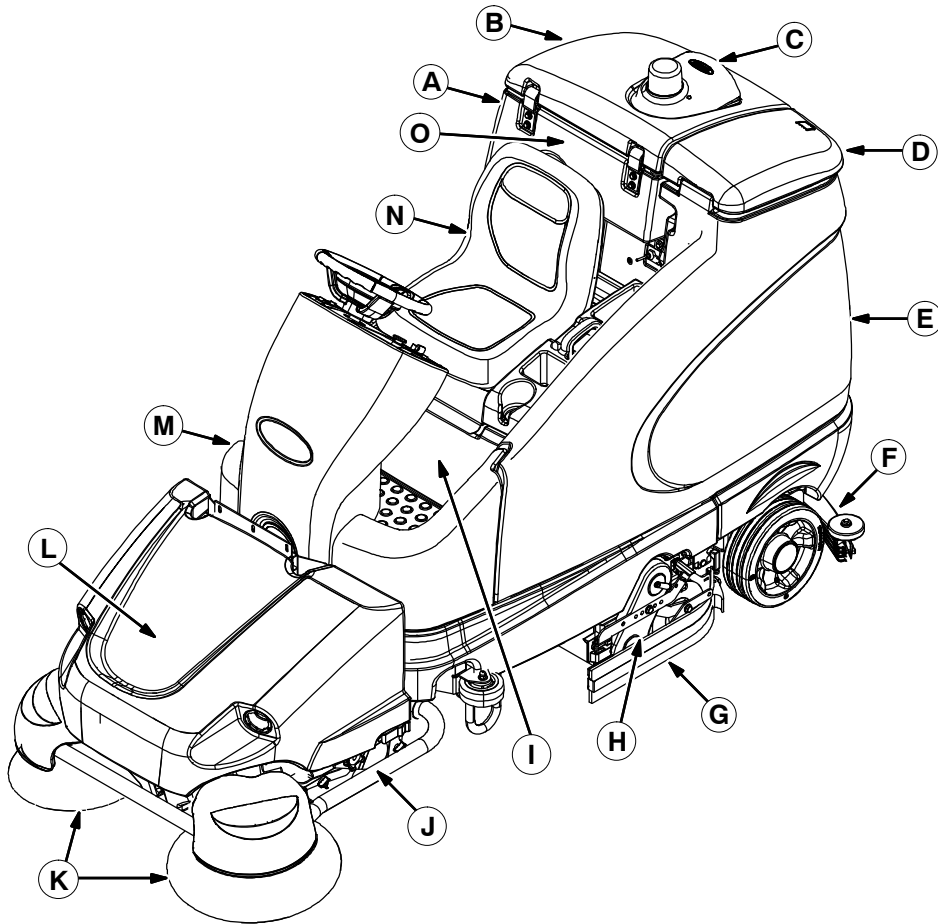

356071

- A. Recovery tank
- B. Recovery tank cover
- C. Backup alarm / flashing light (option)
- D. Solution tank cover
- E. Solution tank
- F. Rear squeegee
- G. Side squeegee
- H. Scrub head
- I. Battery compartment
- J. Pre-Sweep assembly (option)
- K. Pre-Sweep side brushes (option)
- L. Pre-Sweep debris hopper (option)
- M. Side brush (option)
- N. Operator seat
- O. FaST PAK (option)
ec-H2O System Module (option)
FaST solution system (option)

CONTROLS AND INSTRUMENTS



- A. Steering wheel
- B. Touch panel
- C. Side brush switch (option)
- D. Spray nozzle switch (option)
- E. Brake pedal
- F. Propel pedal
- G. Directional switch
- H. Operating lights / hazard lights switch (option)
- I. Key switch
- J. Pre-Sweep switch (option)
- K. Power kill switch

OPERATION



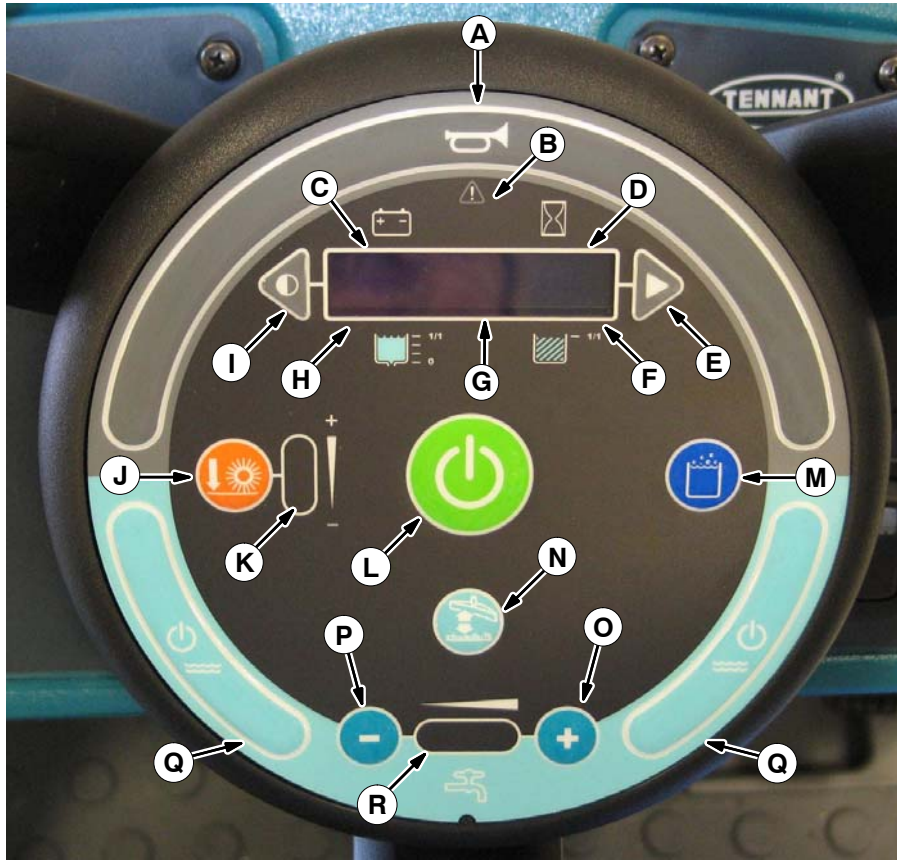























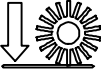



TOUCH PANEL



- A. Horn
- B. Warning / fault indicator light
- C. Battery discharge indicator
- D. Hour meter
- E. Configuration mode button
- F. Recovery tank indicator
- G. LCD display
- H. Solution tank indicator
- I. Contrast control button
- J. Brush pressure button
- K. Brush pressure indicator lights
- L. 1-Step button
- M. Scrub mode (ec-H2O / FaST / ES / conventional) button
- N. Vacuum fan / squeegee button
- O. Solution increase button (+)
- P. Solution decrease button (-)
- Q. Solution on / off buttons
- R. Solution flow indicator lights

SYMBOL DEFINITIONS

These symbols are used on the machine to identify controls, displays, and features.

	Fault indicator		Recovery tank
	Vacuum fan / squeegee		Operating lights
	1-STEP		Hazard light
	ES (extended scrub)		Scrub mode
<i>FaST</i>	FaST (foam scrubbing)		Circuit breaker
<i>ec H₂O</i>	ec-H ₂ O (option)		Spray nozzle
	Solution flow		Pre-Sweep
	Increase		Pre-sweep / Vacuum fan
	Decrease		On
	Main brush pressure		Off
	Side brush		Solution On / Off
	Battery charge		Emergency shutoff
	Horn		Contrast control
	Hour meter		Jack point
	Solution tank		Solution flow (maximum / minimum)
	Forward / Reverse		Brush pressure (maximum / minimum)

OPERATION

INSTALLING BATTERIES



WARNING: Fire Or Explosion Hazard. Batteries Emit Hydrogen Gas. Keep Sparks And Open Flame Away. Keep Battery Hood Open When Charging.

FOR SAFETY: When servicing machine, wear protective gloves and eye protection when handling batteries and battery cables. Avoid contact with battery acid. Battery installation must be done by trained personnel.

BATTERY SPECIFICATIONS

Six 6-volt deep cycle lead acid batteries.

Maximum battery dimensions: 7 in / 177.8 mm W x 11.8 in / 299.7 mm L x 14.5 in / 368 mm H.

1. Park the machine on a level surface and remove the key.
2. To engage the seat support, lift the seat completely open and insert the seat support arm into the hole in the operator seat plate.

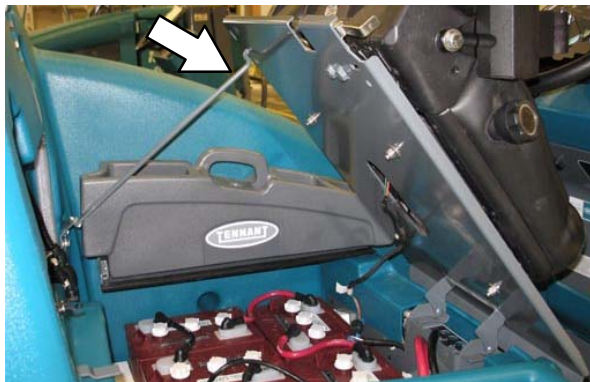
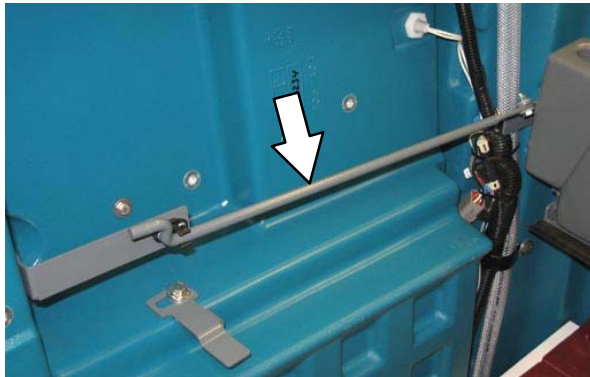

3. Remove the accessory box and tray.

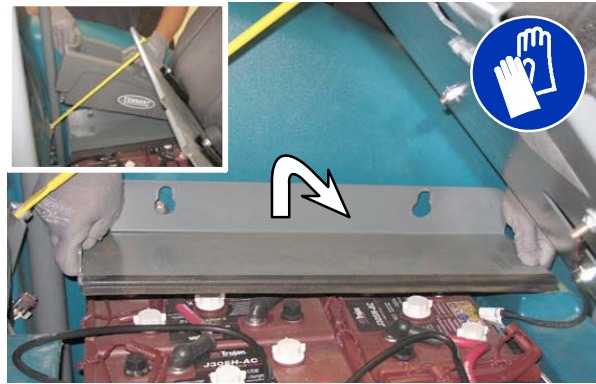

4. With adequate assistance carefully install the batteries into the battery compartment tray and arrange the battery posts as shown. Insert the foam spacers along side the batteries as shown if installing the smaller batteries.

NOTE: For large traction batteries, remove the seat assembly and use a hoist to install the battery.

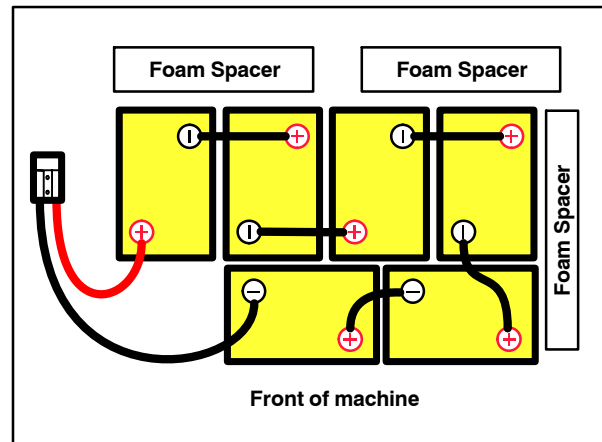

5. Using the supplied battery post boots, connect the cables to the battery posts, RED TO POSITIVE (+) & BLACK TO NEGATIVE (-).
6. Reinstall the accessory box and tray.

IMPORTANT: Make sure that the charger is properly set for the battery type before charging (See ON-BOARD CHARGER SETTINGS).

OPERATION OF CONTROLS

BATTERY DISCHARGE INDICATOR

The *battery discharge indicator* displays the charge level of the batteries while the machine is operating.



When the batteries are fully charged, all five bars are lit. Recharge the batteries when there are no longer any bars shown in the display.

NOTE: The reading on the battery discharge indicator is not accurate when the machine is first powered on. Operate the machine a few minutes before reading the charge level of the batteries.

NOTE: The battery discharge indicator will not reset from the flashing indicator (lowest bar on the indicator) unless the batteries have been fully charged.

HOURLY METER

The *Hour meter* records the hours the machine was operated. Use this information to determine machine service intervals.



RECOVERY TANK INDICATOR

The *recovery tank indicator* displays the amount of liquid in the recovery tank. All scrubbing functions will stop when the recovery tank is full. Empty the recovery tank when the indicator reaches 100%.



SOLUTION TANK INDICATOR

The *solution tank indicator* displays the amount of liquid in the solution tank. Refill the solution tank when there are no longer any bars shown in the display. The machine will stop scrubbing when the solution tank is empty.



OPERATION

POWER KILL SWITCH

The *power kill switch* immediately stops all power to the machine.

Stop machine power: Press the power kill switch.

Restart machine power: Turn the power kill switch to the right to release the switch. Turn the key switch off, then turn the key fully clockwise and release it to the On position.



OPERATING / HAZARD LIGHT SWITCH (OPTION)

Operating and Hazard Lights On: Press the top of the *Operating / hazard light switch*.

Operating Lights On: Press the *Operating / hazard light switch* to the middle position.

All Lights Off: Press the bottom of the *Operating / hazard light switch*.

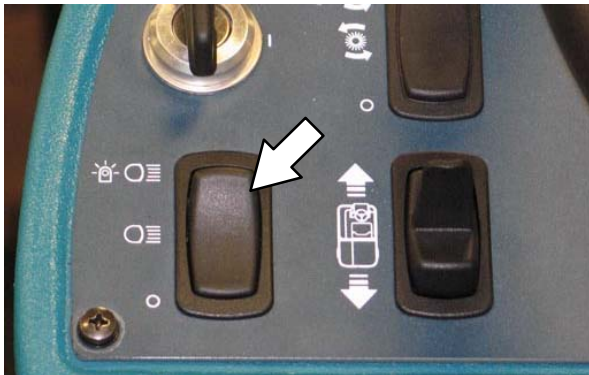

SEAT SUPPORT ARM

The *seat support arm* holds the seat up to allow access to the batteries and circuit breakers.

To engage the seat support arm, lift the seat completely open and insert the seat support arm into the hole in the operator seat plate.

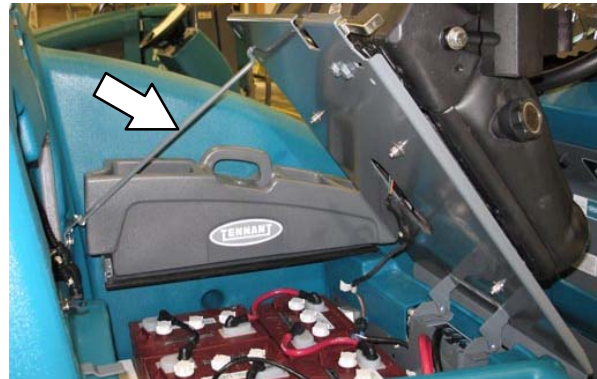
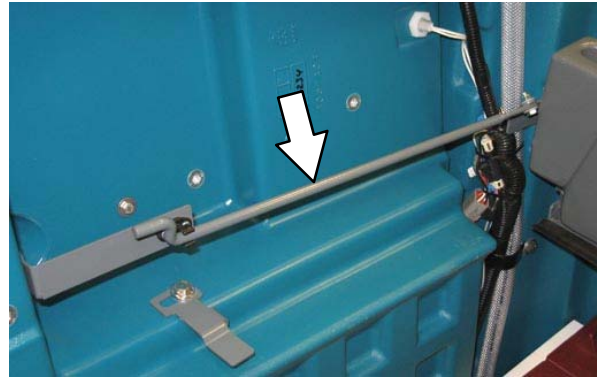

OPERATOR SEAT

The front-to-back adjustment lever adjusts the seat position.

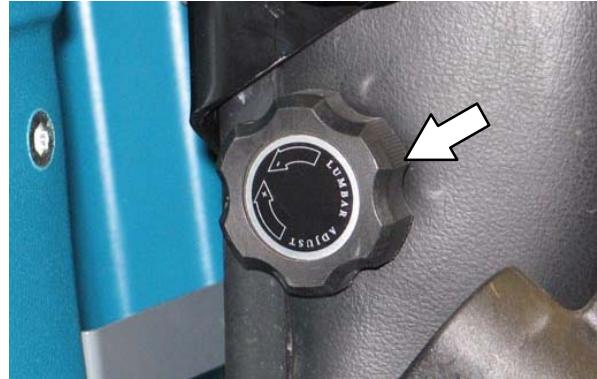

The lumbar knob adjusts the lower backrest portion of the seat.

**DELUXE SUSPENSION SEAT (OPTION)**

The operator seat has four adjustments: backrest angle, operator weight, lumbar, and front to back.

Use caution when tilting the deluxe seat. The deluxe seat is heavier than the standard seat.

The backrest adjustment knob adjusts the angle of the backrest.



The front-to-back adjustment lever adjusts the seat position.

**SEAT BELTS**

FOR SAFETY: Before starting machine, adjust seat and fasten seat belt.

The weight adjustment knob controls the firmness of the operator seat. Use the gauge next to the weight adjustment knob to help determine seat firmness.

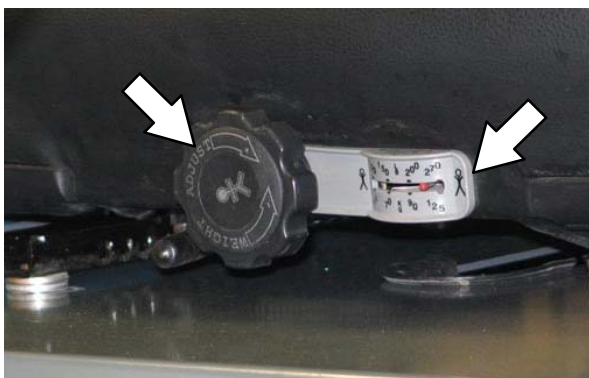

OPERATION

CONTRAST CONTROL BUTTON

Use the *Contrast control button* to darken / lighten the LCD display.



CONFIGURATION MODE BUTTON

The *Configuration mode button* is for accessing the configuration and diagnostic modes. Only properly trained service personnel and TENNANT representatives should access these modes.



PROPEL PEDAL

Press the *Propel pedal* to move the machine.

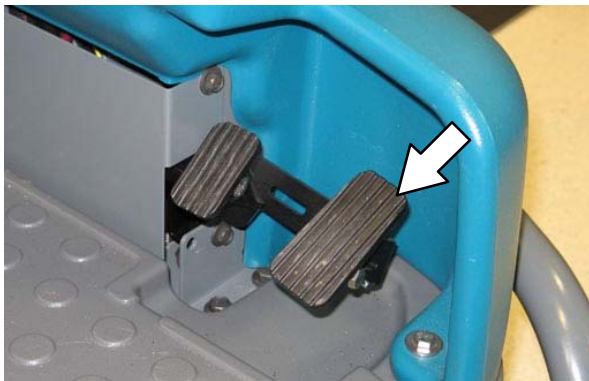

BRAKE PEDAL

Press the *Brake pedal* to stop the machine.

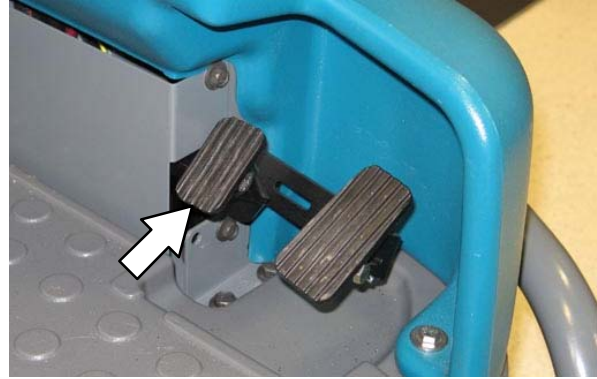

DIRECTIONAL SWITCH

Use the *Directional switch* to select either the forward or reverse direction. Press the propel pedal to move the machine.



NOTE: An audible alarm will sound when the *Directional switch* is placed into reverse.

NOTE: Machines equipped with the optional flashing light / backup alarm only: The optional backup light and alarm will function only when the machine is moving in reverse.

VACUUM FAN / SQUEEGEE BUTTON

Lower squeegee and turn vacuum fan on: Press the *Vacuum fan / squeegee button*. The indicator light will illuminate when the squeegee is lowered.

Raise squeegee and turn vacuum fan off: Press the *Vacuum fan / squeegee button*. The indicator light will go out when the squeegee is raised.

NOTE: The 1-STEP button does not need to be activated to operate the vacuum fan / squeegee system. The vacuum fan / squeegee button can be turned on or turned off with the 1-STEP button either on or off.

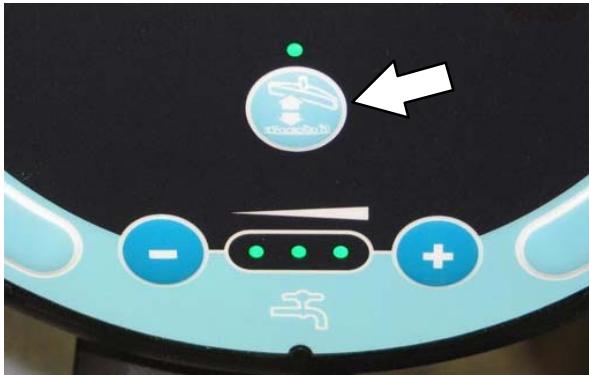

SOLUTION ON / OFF BUTTONS

Shut off the solution flow: Press the *Solution on / off button* to shut off the solution flow. All the solution flow indicator lights will turn off.

Turn on the solution flow: Press the *Solution on / off button* to turn on the solution flow. The solution indicator lights will turn back on and the solution flow will default to the last setting used.



HOW THE MACHINE WORKS

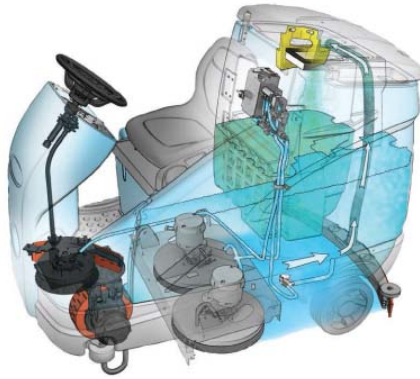

T16 With Disk Brushes

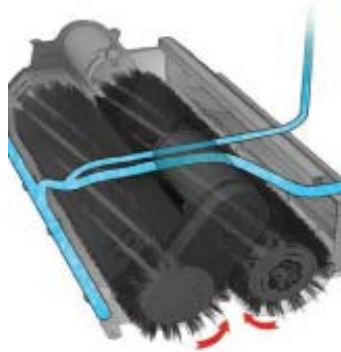

T16 With Cylindrical Brushes

The *1-STEP button* makes it possible to immediately begin scrubbing by operating all the scrubbing functions.

When in the conventional Scrub mode, a water and detergent mixture is used to scrub the floor.

When in the optional ES (Extended Scrub) mode, the dirty solution in the recovery tank is filtered through the ES system and returned to the solution tank for reuse. Detergent is then injected into the returned solution to revitalize the cleaning capability of the solution.

When in the optional FaST (Foam scrubbing) mode, the FaST scrubbing system mixes the FaST-PAK concentrate with a small amount of water, creating a large volume of expanded wet foam. The FaST system can be used with all scrubbing applications.

When in the optional *ec-H2O* (electrically converted water) mode, normal water passes through a module where it is oxygenated and charged with an electric current. The electrically converted water changes into a blended acidic and alkaline solution forming a neutral pH cleaner. The converted water attacks the dirt, breaks it into smaller particles, and pulls it off the floor surface allowing the machine to easily scrub away the suspended soil. The converted water then returns to normal water in the recovery tank. The *ec-H2O* system can be used with all double scrubbing and heavy duty scrubbing applications.

BRUSH AND PAD INFORMATION

For best results, use the appropriate brush or pad for the cleaning application. Listed below are brushes and pads and the applications for which each is best suited.

NOTE: The amount and type of soilage play an important role in determining the type of brush or pad to use. Contact a Tennant representative for specific recommendations.

Nylon brush (Disk)* – Softer nylon bristles are recommended for scrubbing coated floors. Cleans without scuffing.

Polyester brush (Cylindrical) – Softer general purpose polyester bristles gently clean while scrubbing. Perfect for sensitive floor surfaces. Polyester does not absorb water so it is preferred over Nylon in wet applications.

PolyPro brush (Cylindrical) – Heavy duty polypropylene bristles provide a more aggressive cleaning performance and can more easily lift compacted dirt, debris, and sand while offering excellent scrubbing performance.

Polypropylene brush (Cylindrical and Disk)* – General purpose polypropylene bristles lift lightly compacted dirt without scuffing high-gloss coated floors.

Super AB brush (Cylindrical and Disk)* – Nylon fiber with an abrasive grit to remove stains and compacted dirt. Aggressive action on any surface. Performs well on buildup, grease, or tire marks.

** This brush is also available for the side brush.*

Stripping pad (Brown) – Quickly and easily cuts through old finish to prepare the floor for recoating.

Scrubbing pad (Blue) – Removes dirt, spills, and scuffs. Leaves a clean surface ready for recoating.

Buffing pad (Red) – Quickly cleans and removes scuff marks while polishing the floor to a high gloss.

Polishing pad (White) – Maintains a high gloss. Use for buffing very soft finishes and lower traffic areas, and polishing soft waxes on wood floors.

High productivity pad (Black) – Aggressively strips floor finishes/sealers. Use for very heavy-duty scrubbing. *This pad can only be used with the grip pad driver, not the tufted pad driver.*

Surface preparation pad (Maroon) – Aggressively strips floors without use of chemicals.

Grip pad driver – The grip-face backing allows pads to be fully used and holds pads in place without penetrating the pad. The spring-activated centering device works with all Tennant pads and allows for fast, easy pad replacement.

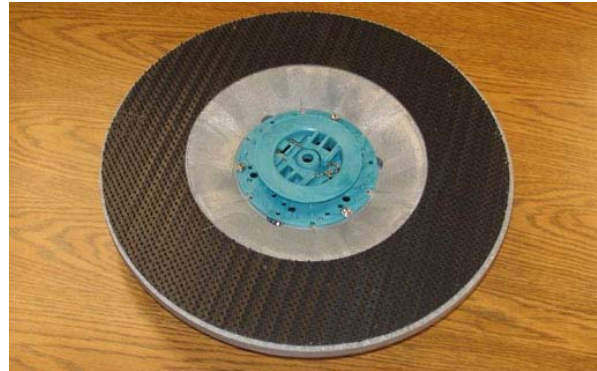

Tufted pad driver – Standard pad driver has short bristles, or “tufts,” on the back to hold the pad in place. This driver works with all Tennant pads except the black high productivity pad.

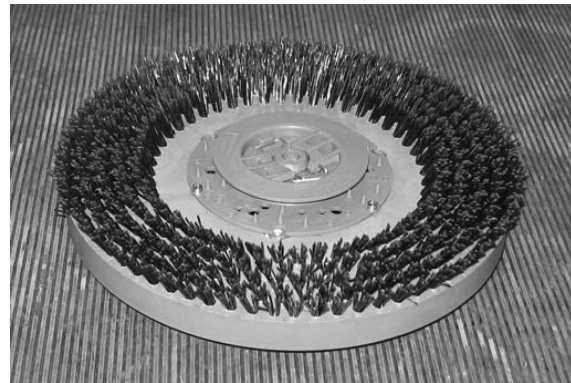

WHILE OPERATING THE MACHINE

Pick up oversized debris before scrubbing. Pick up wire, string, twine, large pieces of wood, or any other debris that could become wrapped around or tangled in the brushes.

Drive in a straight path as possible. Avoid bumping into posts or scraping the sides of the machine. Overlap the scrub paths by several centimeters (a few inches).

Avoid turning the steering wheel too sharply when the machine is in motion. The machine is very responsive to the movement of the steering wheel. Avoid sudden turns, except in emergencies.

Adjust the machine speed, brush pressure, and solution flow as required when scrubbing. Use the lowest brush pressure and solution flow settings for best performance.

If poor cleaning performance is observed, stop cleaning and refer to *MACHINE TROUBLESHOOTING* in this manual.

Perform the Daily Maintenance Procedures after each use (see *MACHINE MAINTENANCE* in this manual).

Drive the machine slowly on inclines. Use the brake pedal to control machine speed on descending inclines. Scrub with the machine up inclines rather than down inclines.

FOR SAFETY: When using machine, go slowly on inclines and slippery surfaces.

Do not operate machine in areas where the ambient temperature is above 43° C (110° F). Do not operate scrubbing functions in areas where the ambient temperature is below freezing 0° C (32° F).

PRE-OPERATION CHECKLIST

Perform the following steps before operating the machine:

- Check the machine for fluid leaks.
- Check the operating lights.
- Check left side squeegee for wear and damage.
- Check main brushes for wear and damage. Remove wire, string, or twine wrapped around the main scrub brushes.
- Machines equipped with cylindrical brushes: Confirm the debris tray is empty and clean.
- Machines equipped with side brush option: Check for wire, string, or twine wrapped around the scrub brush.
- Machines equipped with side brush option: Check squeegee for wear and damage.
- Machines equipped with Pre-Sweep option: Check for wire, string, or twine wrapped around the scrub brush.
- Machines equipped with Pre-Sweep option: Check dust control filter bag.
- Machines equipped with Pre-Sweep option: Confirm debris trough is empty.
- Check the rear squeegees for wear and damage.
- Check the recovery and solution tank cover seals for wear or damage.
- Confirm the vacuum fan inlet filter is clean.
- Check the right side squeegee for wear and damage.
- Machines equipped with ES option: Ensure ES filter at bottom of recovery tank is clean.
- FaST Scrubbing: Check the FaST PAK concentrate agent level, replace carton as needed. See the INSTALLING THE FaST PAK AGENT section of the manual.
- For FaST or *ec-H2O* Scrubbing: Confirm all conventional cleaning agents/restorers are drained and rinsed from the solution tank.
- For FaST or *ec-H2O* Scrubbing: Confirm the solution tank is filled with **clear cool water only**.
- Check the horn, headlights, taillights, safety lights, and backup alarm (if equipped).
- Check the brakes and steering for proper operation.
- Check the tires for damage.
- Check maintenance records to determine maintenance requirements.

OPERATION

STARTING THE MACHINE

FOR SAFETY: Before starting machine, adjust seat and fasten seat belt.

1. Sit in the operators seat.
2. Turn the *key switch* completely past the on position and release the key switch. The key switch will automatically return to the on position.



3. Turn on lights (if equipped).
4. Place the *directional switch* into the direction needed to travel.
5. Press the *propel pedal* to move the machine.

NOTE: The machine will not travel unless the operator is sitting in the operator seat.

FILLING THE SOLUTION TANK

FOAM SCRUBBING (FaST MODE) / ec-H2O SCRUBBING (ec-H2O MODE)

FOR SAFETY: Before leaving or servicing machine, stop on level surface, turn off machine, and remove key.

1. Open the solution tank cover.



2. Fill the solution tank with only clean COOL WATER (less than 21°C / 70°F). DO NOT use hot water or add any conventional floor cleaning detergents or a FaST or ec-H2O system failure may result. Fill the solution tank with water until the level is approximately 50 mm (2 in) below the indicator tab.



WARNING: Flammable materials can cause an explosion or fire. Do not use flammable materials in tank(s).

NOTE: Do not use the FaST or ec-H2O system when there are conventional cleaning detergents in the solution tank. Drain, rinse, and refill the solution tank with clear cool water before operating the FaST or ec-H2O system. Conventional cleaning detergents may cause a FaST or ec-H2O system failure.

3. Close the solution tank cover.

CONVENTIONAL SCRUBBING MODE

FOR SAFETY: Before leaving or servicing machine, stop on level surface, turn off machine, and remove key.

1. Open the solution tank cover.



2. Partially fill solution tank with water (not to exceed 60°C / 140°F). Pour the required amount of detergent into the solution tank. Continue filling the solution tank with water until the level is approximately 50 mm (2 in) below the indicator tab.

WARNING: Flammable materials can cause an explosion or fire. Do not use flammable materials in tank(s).



ATTENTION: For Conventional Scrubbing, only use recommended cleaning detergents. Machine damage due to improper detergent usage will void the manufacturer's warranty.

NOTE: Pour a recommended foam control solution into the recovery tank if excessive foam appears. For specific detergent recommendations, contact a Tennant representative.

3. Close the solution tank cover.

OPERATION

ES (EXTENDED SCRUB) MODE

FOR SAFETY: Before leaving or servicing machine, stop on level surface, turn off machine, and remove key.

1. Open the solution tank cover.



2. Fill solution tank with water (not to exceed 60°C / 140°F). Fill the solution tank with water until the level is approximately 50 mm (2 in) below the indicator tab.



3. Fill the recovery tank with water (not to exceed 60°C / 140°F). Fill the recovery tank to just above the top of the ES filter.

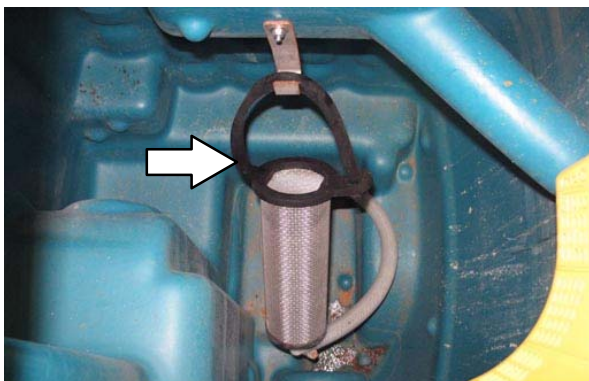

4. Fill the ES detergent tank with detergent.

WARNING: Flammable materials can cause an explosion or fire. Do not use flammable materials in tank(s).

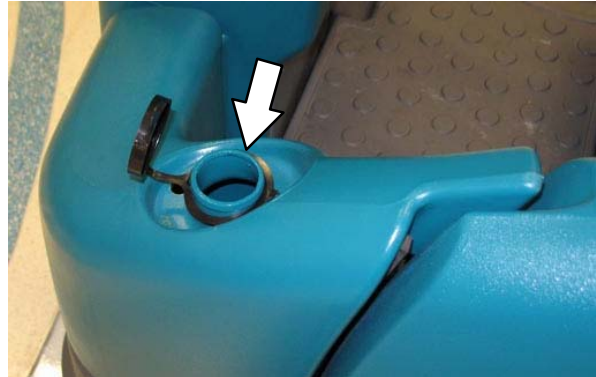

5. Close the solution tank cover.

SETTING SCRUB MODES

The *Scrub mode button* enables the scrubbing functions to come on when the *1-STEP button* is activated. The light and cleaning system logo next to the button will come on. The machine will default to the last setting used when it is powered on or off.



NOTE: When the ES system is turned on there is a slight delay before the ES pump begins operating.

SETTING BRUSH PRESSURE

Under normal cleaning conditions, the brush pressure should be set to the lowest setting (the bottom light). Under heavy grime conditions, the brush pressure can be set to a higher setting (the top two lights). Travel speed and floor conditions will affect cleaning performance.

With the *1-STEP button* activated, press the *Brush pressure button* to set the brush pressure. Use the *Brush pressure button* to both raise or lower the brush pressure settings. If brushes are worn, it may be necessary to increase the brush pressure. The machine will default to the last setting used when it is powered on or off.



SETTING SOLUTION FLOW

With the *1-STEP button* activated, press either *Solution increase button (+)* or *Solution decrease button (-)* to set the solution flow level. Travel speed and floor conditions will affect scrubbing performance. The machine will default to the last setting used when the machine is powered on or off. The solution flow indicator lights display the current solution flow setting.

NOTE: When using the FaST or ec-H2O system (option), the solution flow increase and solution flow decrease buttons are nonfunctional. The FaST and ec-H2O system flow rates are pre-set. All three solution flow indicator lights will be lit if the machine is in the ec-H2O or FaST mode.

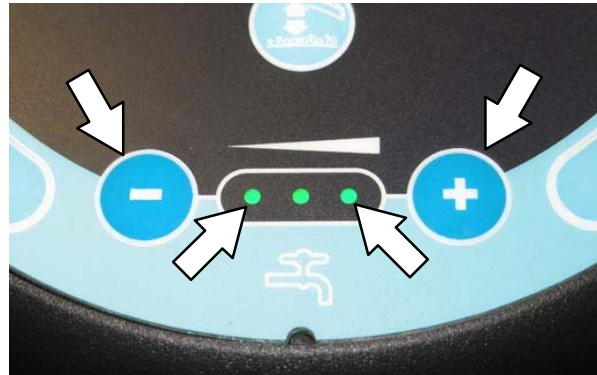

CONVENTIONAL SOLUTION FLOW

Under normal soilage conditions the solution flow level should be set to the lowest setting (the left light). Under heavy grime conditions, the solution flow level should be set to the higher settings (middle or right lights).

ES (EXTENDED SCRUB) SOLUTION FLOW

For ES machines, the detergent flow is turned off when the solution flow is in the lowest setting (one light). The middle setting (two lights) and highest setting (three lights) allow solution AND detergent flow. The lowest setting (one light) allows solution flow WITHOUT adding detergent. Detergent does not have to be continuously added with the solution flow to attain effective scrubbing results. Under normal soilage conditions, the solution flow level should be alternated between the middle and lowest setting.

OPERATION

SCRUBBING

FOR SAFETY: Do not operate machine, unless operator manual is read and understood.

1. Start the machine.
2. Press the *1-STEP* button. The light near the button will come on. All the preset scrubbing functions will turn on.



3. Press the *scrub mode* button to select the scrub mode (ec-H2O, FaST, or ES). The indicator light and mode logo will illuminate.



4. If necessary, adjust the brush pressure and solution flow.
5. Place the *directional switch* in the direction the machine is to be moved (forward or reverse).
6. Press the *propel pedal* to begin scrubbing.

NOTE: DO NOT turn on the FaST or ec-H2O system during conventional scrubbing. Conventional cleaning detergents could cause a FaST or ec-H2O system failure. Drain, rinse, and refill the solution tank with cool clean water before operating the FaST or ec-H2O system.



WARNING: Flammable materials or reactive metals can cause an explosion or fire. Do not pick up.

FOR SAFETY: When using machine, go slowly on inclines and slippery surfaces.

NOTE: The squeegee automatically rises when the machine is driven in reverse. This prevents damage to the squeegee.

ec-H2O Model: If an alarm sounds and the warning / fault indicator indicator light flashes the ec-H2O module must be flushed to resume ec-H2O operation (See ec-H2O MODULE FLUSH PROCEDURE).

NOTE: When the alarm sounds press the scrub mode button to shut off the ec-H2O system and continue scrubbing or flush the ec-H2O system.

ec-H2O SYSTEM INDICATOR LIGHT CODE	CONDITION
Solid blue indicator light	Normal operation
Flashing red warning / fault indicator light	Flush ec-H2O module
Solid red warning / fault indicator light	Contact Service Center

7. Release the *directional pedal* and press the *brake pedal* to stop the machine.
8. Press the *1-STEP* button to stop scrubbing. The light near the button will go off and scrubbing functions will stop after a short delay.

DOUBLE SCRUBBING

Use the double scrubbing method to clean heavily soiled areas.

Double scrubbing can be performed using the FaST SCRUBBING SYSTEM (option), ec-H2O SCRUBBING SYSTEM (option) or CONVENTIONAL SCRUBBING methods.

Pre-sweep and side brush (option) machines: Leave the Pre-sweep and side brush (options) in the raised position while double scrubbing.

To raise the side squeegees for double scrubbing, remove the clevis pins from the storage locations. Manually raise both side squeegee assemblies, then reinsert the pins into the holes in the side squeegee brackets.

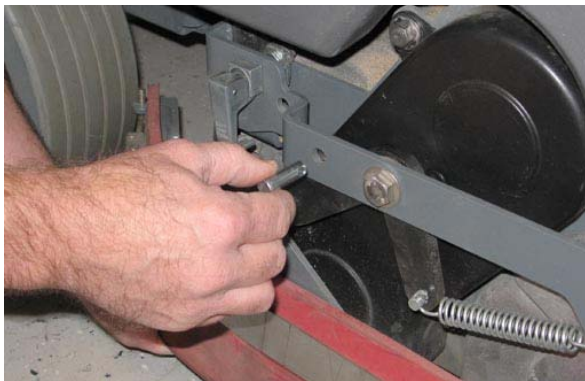

Press the 1-STEP button and then the Vacuum fan/squeegee button. The light above the Scrub vacuum fan/squeegee button will turn off, the squeegee will rise, and the vacuum fan will stop operating. Scrub the heavily soiled area. Let the cleaning solution soak on the floor for 5-15 minutes.



FOR SAFETY: When using machine, go slowly on inclines and slippery surfaces.

Before scrubbing the floor a second time, lower the side squeegees and press the Vacuum fan/squeegee button to lower the rear squeegee and turn on the vacuum fan. The light above the button will come on. Scrub the floor a second time to pick up the cleaning solution.



WARNING: Flammable materials or reactive metals can cause an explosion or fire. Do not pick up.

NOTE: To turn off the solution flow when scrubbing the area a second time, press the Solution on / off button. Press the Solution on / off button again to restart the solution flow.



NOTE: Double scrubbing is not recommended in areas where the cleaning solution will run under racks or damage products.

OPERATION

WATER PICKUP MODE (NO SCRUBBING)

The machine can be used to pick up water or non-flammable liquid spills without scrubbing.

To pick up water or non-flammable liquid spills, make sure the *1-STEP button* is not activated. The light above the button must be off.

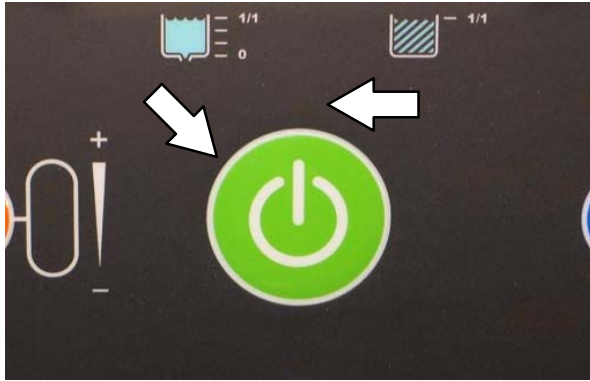

WARNING: Flammable materials or reactive metals can cause an explosion or fire. Do not pick up.

Press the *Vacuum fan/squeegee button*. The light above the button will come on, the squeegee will lower, and the vacuum fan will start operating. Pick up the water or non-flammable liquid spill.



STOP SCRUBBING

1. While the machine is still in motion, press the *1-Step button* to stop the scrubbing operations. The squeegee will briefly remain lowered to the floor to pick up the water in the scrub head.

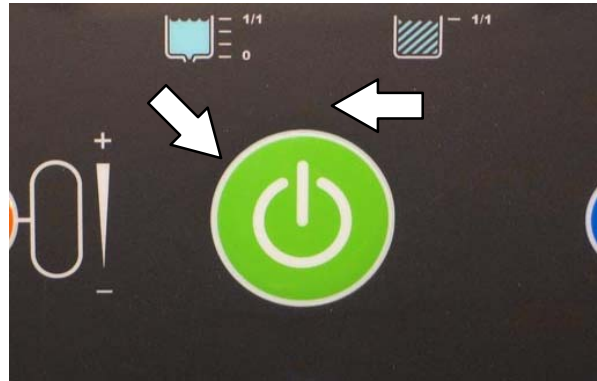

2. Release the *propel pedal* and press the *brake pedal* to stop the machine.

DRAINING AND CLEANING THE RECOVERY TANK

Drain and clean the recovery tank daily or when the recovery tank full fault code appears on the LCD display.

Clean the outside of the tank with vinyl cleaner.

1. Drive the machine near a floor drain.

FOR SAFETY: Before leaving or servicing machine, stop on level surface, turn off machine and remove key.

2. Unhook the recovery tank drain hose from the recovery tank.

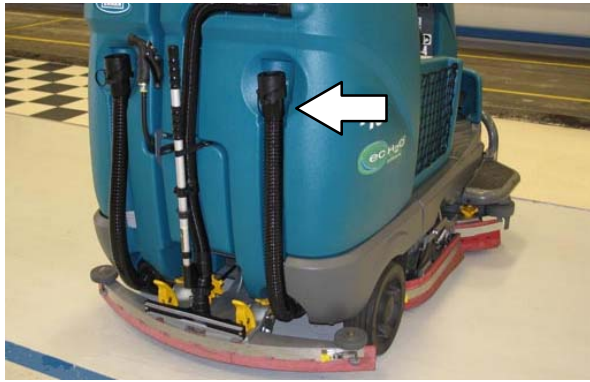

3. Hold the drain hose near a floor drain, twist the drain nozzle open, and place the hose near the floor drain.

NOTE: Be sure the drain hose nozzle is pointed in a safe direction before opening the nozzle.



4. If necessary, twist the drain nozzle to another position to adjust the flow rate.

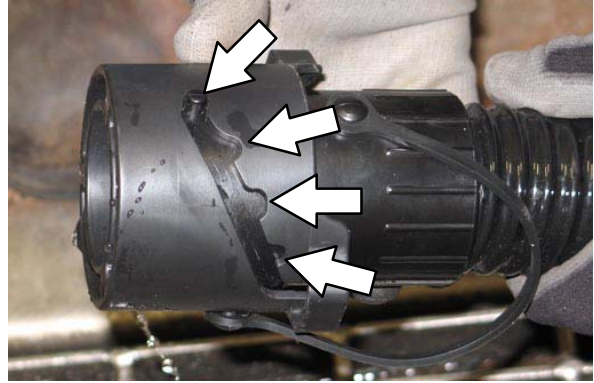

5. Lift the recovery tank cover and flush out the recovery tank with clean water. Rinse the sensor near the top of the tank

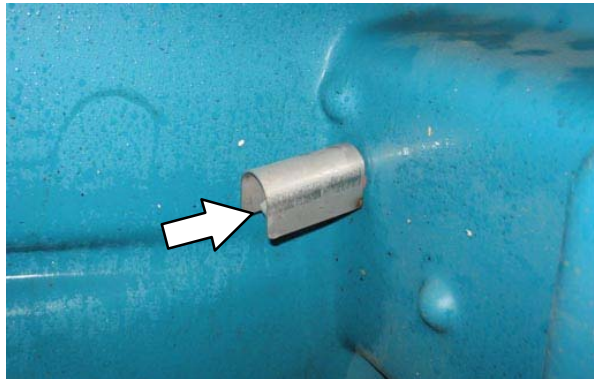

OPERATION

6. ES machines: Rinse the ES filter at the bottom of the tank and the sensor near the top of the tank.

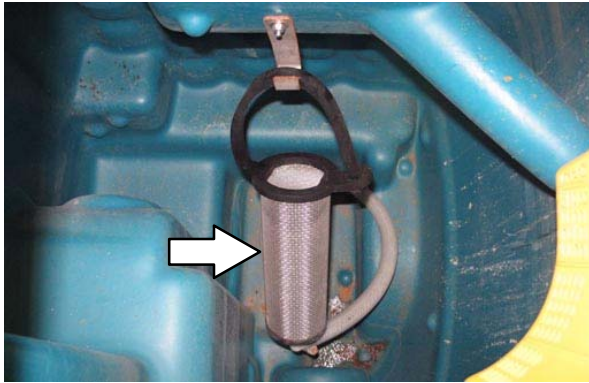

NOTE: DO NOT use steam to clean the tanks. Excessive heat can damage the tanks and components.

7. To prevent leaks, clean the plug portion of the nozzle and the interior of the drain hose cuff.



8. Twist the drain cuff closed and insert the drain hose back into the clip on the recovery tank.



9. Check the vacuum fan inlet filter daily. Clean inlet filter with a damp cloth or hose when dirty. Allow filter to completely dry before reinstalling it into the machine.

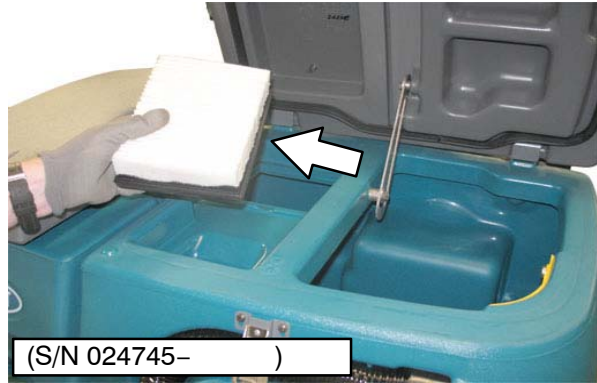

10. Close the recovery tank cover.

11. Cylindrical scrub head: Remove and clean the debris trough. Place the trough back in the scrub head when clean.



NOTE: The scrub head must be lowered approximately 25 mm (1 in) to remove debris trough.

NOTE: The debris trough can be removed from the right side of the machine only.

DRAINING AND CLEANING THE SOLUTION TANK (ES MACHINES ONLY)

ES machines: The solution tank should be drained and cleaned when the recovery tank is drained and cleaned.

Clean the outside of the tank with vinyl cleaner.

1. Drive the machine near a floor drain.

FOR SAFETY: Before leaving or servicing machine, stop on level surface, turn off machine and remove key.

2. Unhook the solution tank drain hose from the solution tank.

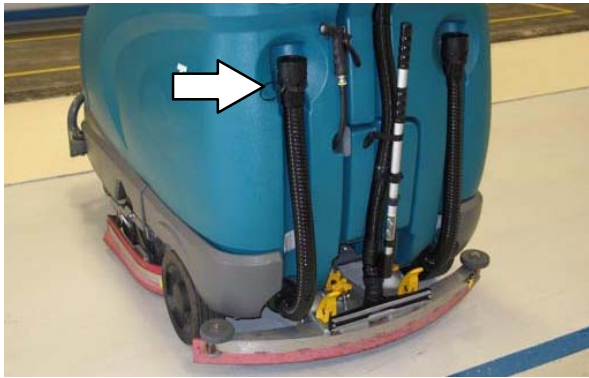

3. Hold the drain hose near a floor drain, twist the drain nozzle open, and place the hose near the floor drain.

NOTE: Be sure the drain hose nozzle is pointed in a safe direction before opening the nozzle.



4. If necessary, twist the drain nozzle to another position to adjust the flow rate.

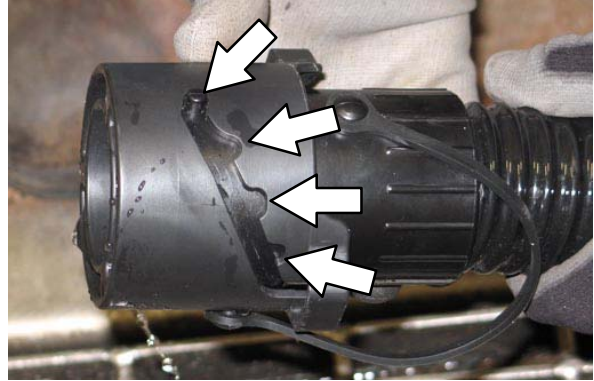

5. Lift the solution tank cover and flush out the solution tank with clean water. Rinse the filter and sensor located inside the solution tank.

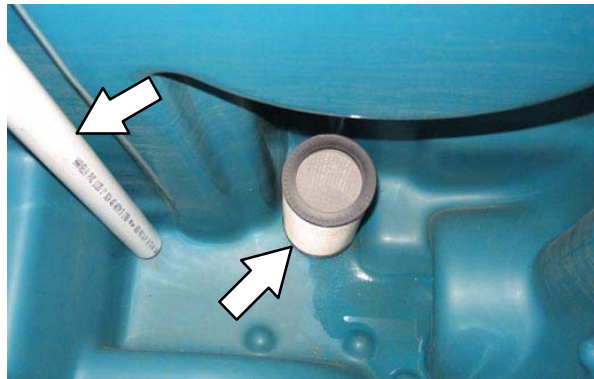

NOTE: DO NOT use steam to clean the tanks. Excessive heat can damage the tanks and components.

OPERATION

6. To prevent leaks, clean the plug portion of the nozzle and the interior of the drain hose cuff.



7. Twist the drain cuff closed and insert the drain hose back into the clip on the solution tank.



TURN OFF THE MACHINE

1. Remove foot from the *propel pedal*.
2. Press the *1-Step* button to stop scrubbing.
3. Press the *brake pedal* to stop the machine.
4. Turn the *key switch* to the off position.



FAULT INDICATOR(S)

This machine is equipped with two visual indicators, a red indicator light and an LCD (liquid crystal display).

The red indicator light will blink continuously indicating that a fault has occurred.

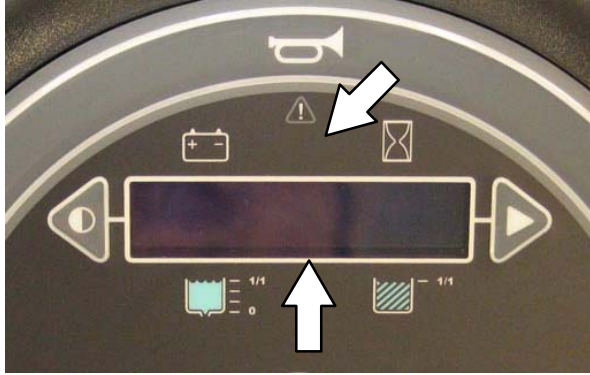

The LCD will display a fault code. If there is more than one fault, each fault code will alternately display.

All faults codes are also accompanied by an audible alarm to alert the operator a fault has occurred.

To reset the fault indicators, turn the machine off, then eliminate the cause of the fault. The fault indicator will reset when the machine is restarted.

Refer to the table below to determine the cause and remedy for the fault.

Fault Code (Displayed in LCD)	Cause(s)	Remedy
F1: Rec Tank Full	Recovery tank is full	Empty recovery tank
F2: Sol Tank Empty	Solution tank is empty	Fill solution tank.
F3: Vac # Flt #	vacuum fan motor(s) not operating	Shut off and restart machine. If fault code still appears, stop using machine and contact Tennant service representative.
F4: Batt Very Low	Low battery charge	Recharge battery
F5: Propel Error	Propel controller error	Turn off and restart machine.
F6: Left Br Flt #	Left brush not operating	If fault code still appears, stop using machine and contact Tennant service representative.
F6: Frnt Br Flt#	Front brush not operating	
F7: Rght Br Flt#	Right brush not operating	
F7: Rear Br Flt#	Rear brush not operating	
F8: Hi B3 Current	Side brush not operating	
F11: Act Timeout	Main head actuator time out fault	
F12: Check Brushes	Brushes not operating	
F13: Brsh Mtr Flt	Brush motor(s) not operating	

OPERATION

WARNING CODES

Warning codes are typically caused by the operator attempting to activate modes that are not available. The warning code will appear in the LCD.

Refer to the table below to determine the cause of the warning code.

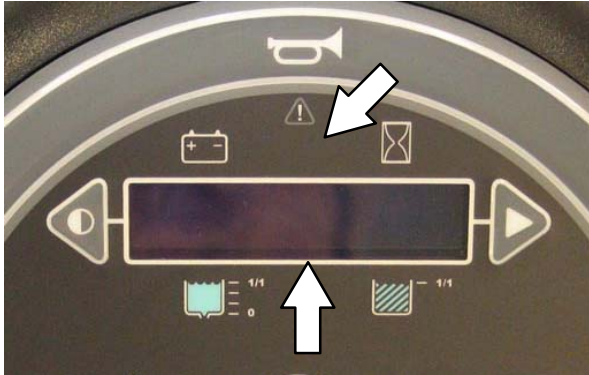

Warning Code (Displayed in LCD)	Cause(s)	Remedy
W1: Batt. Low	Low battery charge	Charge batteries
W2: Sqge Stall	Squeegee not lowering	Check squeegee / squeegee actuator for obstructions or damage
W3: Side Stall	Side brush not lowering	Check side brush actuator for obstructions
W4: Unavailable	Optional solution not enabled	Solution mode not available
W5: No Side Brush	Side brush not enabled	Side brush not available
W6: Not Used	-	-
W7: Not Active	Button inactive	Button not active for use
W8: No Vac. Amps	Vacuum fan not operating	Check harness connection. Reconnect harness if it is unconnected. If warning code still appears, stop using machine and contact Tennant service representative.
W9: Open R/R Brush	Right / rear brush not operating	
W10: Open L/F Brush	Left / front brush not operating	
W11: Open SD Brush	Side brush not operating	
W12: Solution Off	No solution flow to scrub head	Press Solution on / off button to start solution flow.

OPTIONS

SIDE BRUSH (OPTION)

The side brush moves debris into the path of the main brushes.

WARNING: Flammable materials or reactive metals can cause an explosion or fire. Do not pick up.

1. Turn on the machine
2. Press the *1-Step* button.
3. Press the top of the *side brush switch* to lower and start the side brush.



4. Press the *propel pedal* to begin scrubbing.
5. Press the bottom of the *side brush switch* to stop and raise the side brush.

PRE-SWEEP ASSEMBLY (OPTION)

The Pre-Sweep assembly is mounted to the front of the machine and gives the machine the added ability to pick up debris. The assembly contains a main brush and two side brushes which sweep debris into a debris hopper. Periodically empty the debris hopper and vacuum debris bag.

The machine may be operated with or without the Pre-Sweep assembly. Refer to PRE-SWEEP in the MAINTENANCE section for maintenance.

WARNING: Flammable materials or reactive metals can cause an explosion or fire. Do not pick up.

1. Turn on the machine
2. Press the *1-Step* button.

NOTE: Do not press the *1-Step* button if only using to sweep. The Pre-Sweep can be used without the scrubbing features.

3. Press the *Pre-Sweep switch* to the middle position to start the Pre-Sweep *without* dust control.

Press the *Pre-Sweep switch* to the top position to start the Pre-Sweep *with* dust control.

NOTE: The Pre-Sweep assembly will begin sweeping and the dust control system will start operating when the machine propels forward.



4. Press the bottom of *Pre-Sweep switch* to shut off the Pre-sweep system and dust control system.

OPERATION

EMPTY THE PRE-SWEEP DEBRIS HOPPER

FOR SAFETY: Before leaving or servicing machine, stop on level surface, turn off machine and remove key.

1. Lift the Pre-Sweep assembly cover and lock the cover open.



2. Remove the debris hopper from the Pre-Sweep assembly and empty the hopper.



3. Reinstall the debris hopper into the Pre-Sweep assembly.

4. Check the vacuum debris bag. Replace the vacuum debris bag if it is full or damaged.



5. Unlock and lower the Pre-Sweep cover.

VACUUM WAND (OPTION)

Use the vacuum wand to clean areas that are out of reach of the machine.

WARNING: Flammable materials or reactive metals can cause an explosion or fire. Do not pick up.

1. Unsnap the vacuum wand lanyard from the solution tank.



2. Remove the vacuum wand / squeegee vacuum hose from the rear squeegee.



3. Insert the vacuum wand cap into the vacuum port in the vacuum wand.

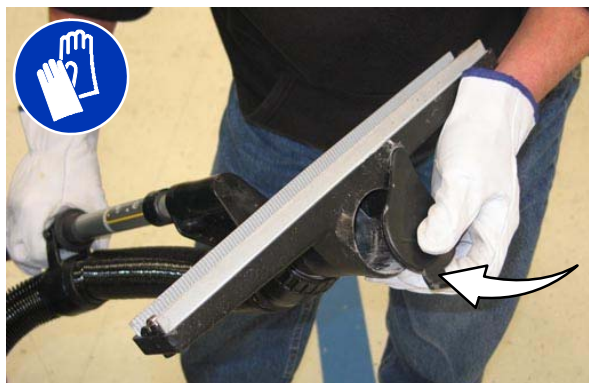

4. Twist the vacuum nozzle to the vacuum position and extend the handle to the desired length.



5. Press the *Vacuum fan/squeegee button* to turn on the vacuum fan. The squeegee will completely lower.



6. Vacuum the floor.



7. When finished vacuuming, press the *Vacuum fan/squeegee button* to turn off the vacuum fan. The squeegee will raise.

8. Turn off the machine.

OPERATION

9. Remove the vacuum wand cap from the vacuum port and return the vacuum nozzle to the storage position and the handle to the storage length.

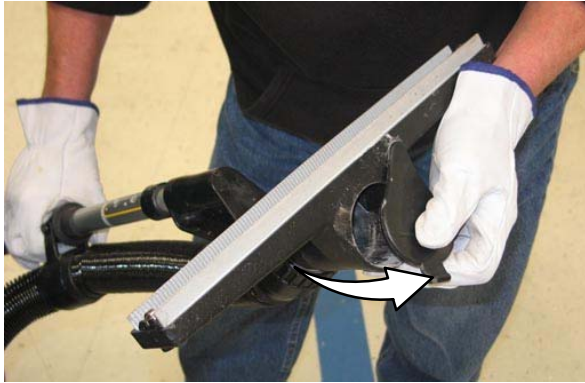

10. Reinstall the vacuum wand / squeegee vacuum hose onto the rear squeegee.
11. Insert the vacuum hose into the vacuum hose recess in the recovery tank.



12. Snap the vacuum wand lanyard onto the solution tank to secure the vacuum wand / squeegee vacuum hose to the machine.

ADJUSTING BACKUP ALARM VOLUME (OPTION)

FOR SAFETY: When using machine, follow site safety guidelines concerning backup alarms.

The backup alarm volume can be adjusted from 85–102 dB(A). To adjust the volume, remove the backup alarm cover and turn the volume knob.

Increase volume: Turn the knob clockwise.

Decrease volume: Turn the knob counter-clockwise.

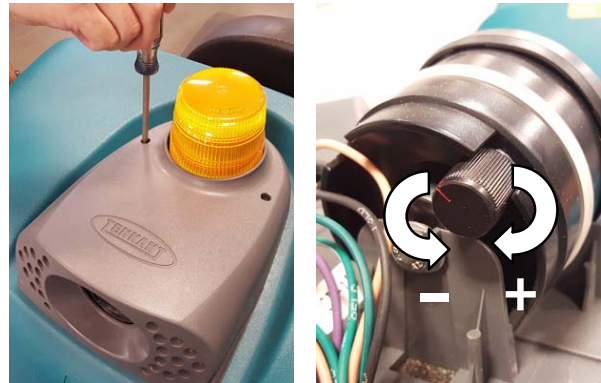

ROLLOUT BATTERY (OPTION)

The rollout battery allows the operator a quick and easy way to remove and replace the batteries from the machine.

FOR SAFETY: Before leaving or servicing machine, stop on level surface, turn off machine and remove key.

1. Lift the operator seat and engage the seat support arm.
2. Open the battery compartment door.



3. Disconnect the machine connector from the batteries.



4. Push the battery cart to the operator side of the machine and align the battery cart with the battery compartment.

5. Rotate the rollout battery retainer handle toward the front of the battery compartment, lower the rollout battery retainer plate, and insert the retainer plate catch into the slot in the battery cart.

NOTE: The retainer plate catch must be completely inserted into the slot in the battery cart to hold the battery retainer handle up and allow the batteries to be safely pulled from the battery compartment.

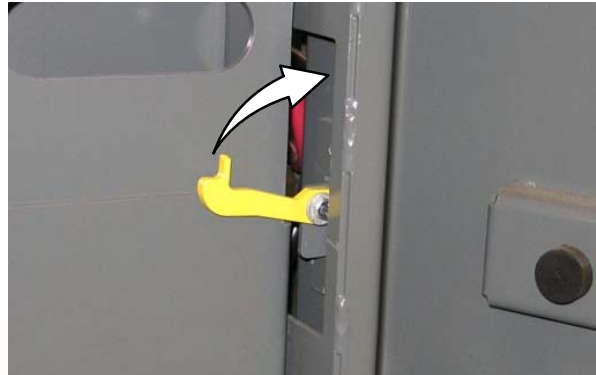

6. Step on the left side of floor lock to set the battery cart floor lock.



OPERATION

7. If necessary, adjust the height of the battery cart rollers. The battery cart rollers must be level with the machine battery rollers. Adjust the height on both sides of the battery cart.

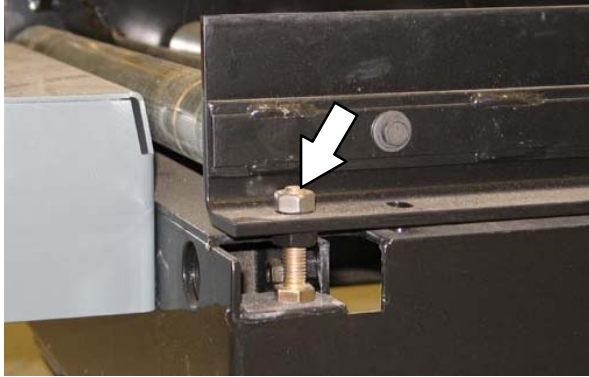

Raise battery cart rollers: Use a wrench to loosen the jam nut and turn the bolt clockwise. Retighten the jam nut.

Lower battery cart rollers: Use a wrench to loosen the jam nut and turn the bolt counter-clockwise. Retighten the jam nut.

8. Pull the battery case onto the battery cart.



9. Pull up on the handle to lower the cart battery stop bar. This will keep the batteries from rolling off the cart.

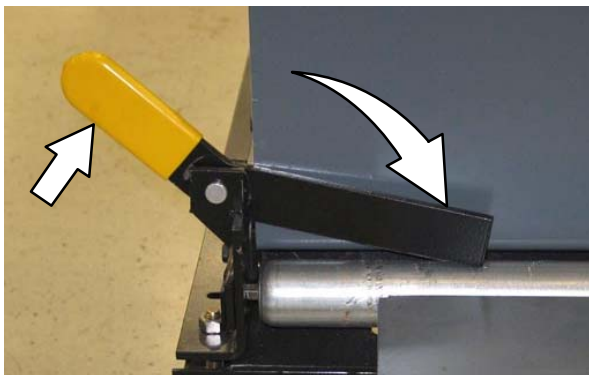

10. Raise the rollout battery retainer plate to release the battery cart from the machine.
11. Release the battery cart floor lock.
12. Pull the battery cart away from the machine.
13. Perform the previous steps in the reverse order to install batteries into the machine.

REAR SQUEEGEE GUARD (OPTION)

The rear squeegee protector helps protect the rear squeegee from being damaged.



To engage the rear squeegee protector, pull the pin, lower the protector bar, and reinsert the pin.

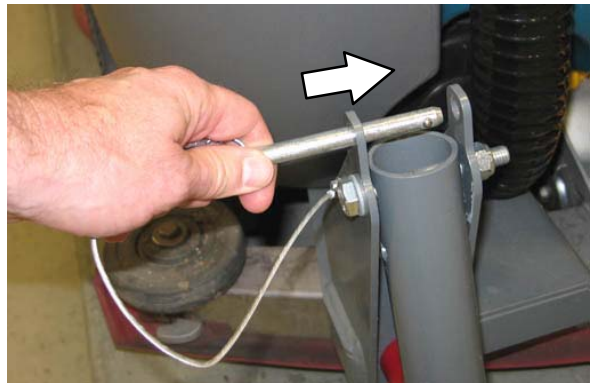

SPRAY NOZZLE (OPTION)

The spray nozzle is used to clean the machine and surrounding areas. The solution tank provides a water/solution supply for the spray nozzle.

NOTE: DO NOT get water on electronic components when using the spray nozzle to clean the machine.

FOR SAFETY: Before leaving or servicing machine, stop on level surface and turn off machine.

1. Turn on the machine.
2. Press the top of the *Spray nozzle switch* to turn on the spray nozzle. The light on the switch will come on when the spray nozzle is turned on.



3. Pull the spray nozzle out from the back of the machine and clean as needed.

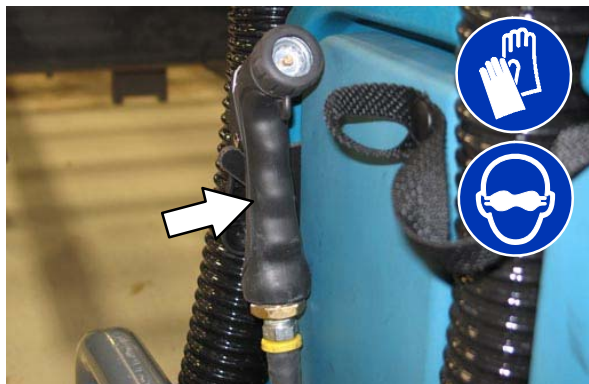

4. When finished cleaning, gently pull the hose and allow the spray nozzle hose to retract back into the machine.

NOTE: Continue holding onto the spray nozzle and control the hose while it is retracting back into the machine. The machine and / or the spray nozzle assembly could be damaged if the spray nozzle hose is released and allowed to rapidly retract into the machine.

5. Place the spray nozzle onto the hook.

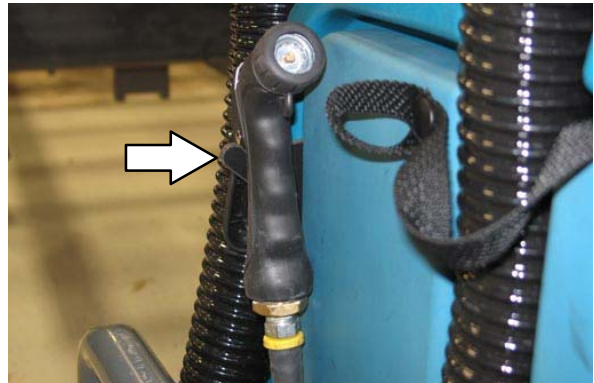

6. Press the bottom of the *Spray nozzle switch* to turn off the water supply. The light on the switch will turn off when the spray nozzle is turned off.

OPERATION

MACHINE TROUBLESHOOTING

Problem	Cause	Remedy
Trailing water – poor or no water pickup	Worn squeegee blades	Rotate or replace squeegee blades
	Squeegee out of adjustment	Adjust squeegee
	Vacuum hose clogged	Flush vacuum hose
	Vacuum fan inlet filter dirty	Clean inlet filter
	Debris caught on squeegee	Remove debris from squeegee
	Vacuum hose to squeegee or recovery tank disconnected or damaged	Reconnect or replace vacuum hose
	Tank cover not completely closed	Check for obstructions
	Torn seals on recovery tank	Replace seals
Vacuum fan will not turn on	Recovery tank full	Drain recovery tank
	Foam filling recovery tank	Empty recovery tank
		Use less or change detergent
		Use a defoamer
Little or no solution flow to the floor	Solution tank empty	Fill solution tank
	Solution flow turned off	Turn solution flow on
	Solution supply lines plugged	Flush solution supply lines
	Solution solenoid clogged or stuck	Clean or replace
Poor scrubbing performance	Debris caught on scrub brushes	Remove debris from brushes
	Improper detergent or brush used	Contact TENNANT representative for recommendations
	Worn scrub brush(es)	Replace scrub brush(es)
	Excessive brush pressure	Reduce scrub brush down pressure
	Uneven brush pressure	Level scrub head
	Broken brush drive belts on cylindrical scrub head	Replace belts
	Low battery charge	Charge batteries until the charger automatically turns off
Poor sweeping performance (Machines equipped with Pre-Sweep option only)	Brush bristles worn	Replace brush
	Debris caught in brush drive mechanism	Remove debris from the drive mechanism.
	Hopper full	Empty hopper
	Vacuum debris bag full	Replace vacuum debris bag
	Recirculation skirt damaged	Replace recirculation skirt
	Wrong sweeping brush	Contact TENNANT representative for recommendations
	Main brush drive failure	Contact TENNANT service personnel

Problem	Cause	Remedy
ES System does not operate	<i>ES button</i> is turned off	Turn on <i>ES button</i>
	ES sensor in tank dirty not in correct position	Clean / reposition sensor
	Clogged ES pump filter	Clean ES filter
	Water level in recovery tank too low	Fill recovery tank about half full
	Water level in solution tank too low	Fill solution tank
FaST System does not operate	FaST button is turned off	Turn on the FaST button
	FaST circuit breaker tripped	Determine cause and reset the 15A circuit breaker button
	Clogged FaST PAK supply hose and/or connector	Soak connector and hose in warm water and clean
	FaST PAK carton is empty or not connected	Replace FaST PAK carton and/or connect supply hose
	FaST system is not primed	To prime, operate the FaST solution system for 5 to 10 minutes
	Clogged flow control orifice/screen	Remove and clean orifice/screen
	Faulty pump	Contact Tennant representative
	Clogged filter screen	Drain solution tank and clean filter screen
	Faulty detergent timer module	Contact Tennant representative
ec-H2O Model: Warning and fault indicator light blinking red	Mineral deposit build-up in module	Flush module (See <i>ec-H2O</i> MODULE FLUSH PROCEDURE)
ec-H2O Model: Warning and fault indicator light solid red	Clogged module	Contact Service Center
	Defective solution pump	Replace solution pump

MAINTENANCE

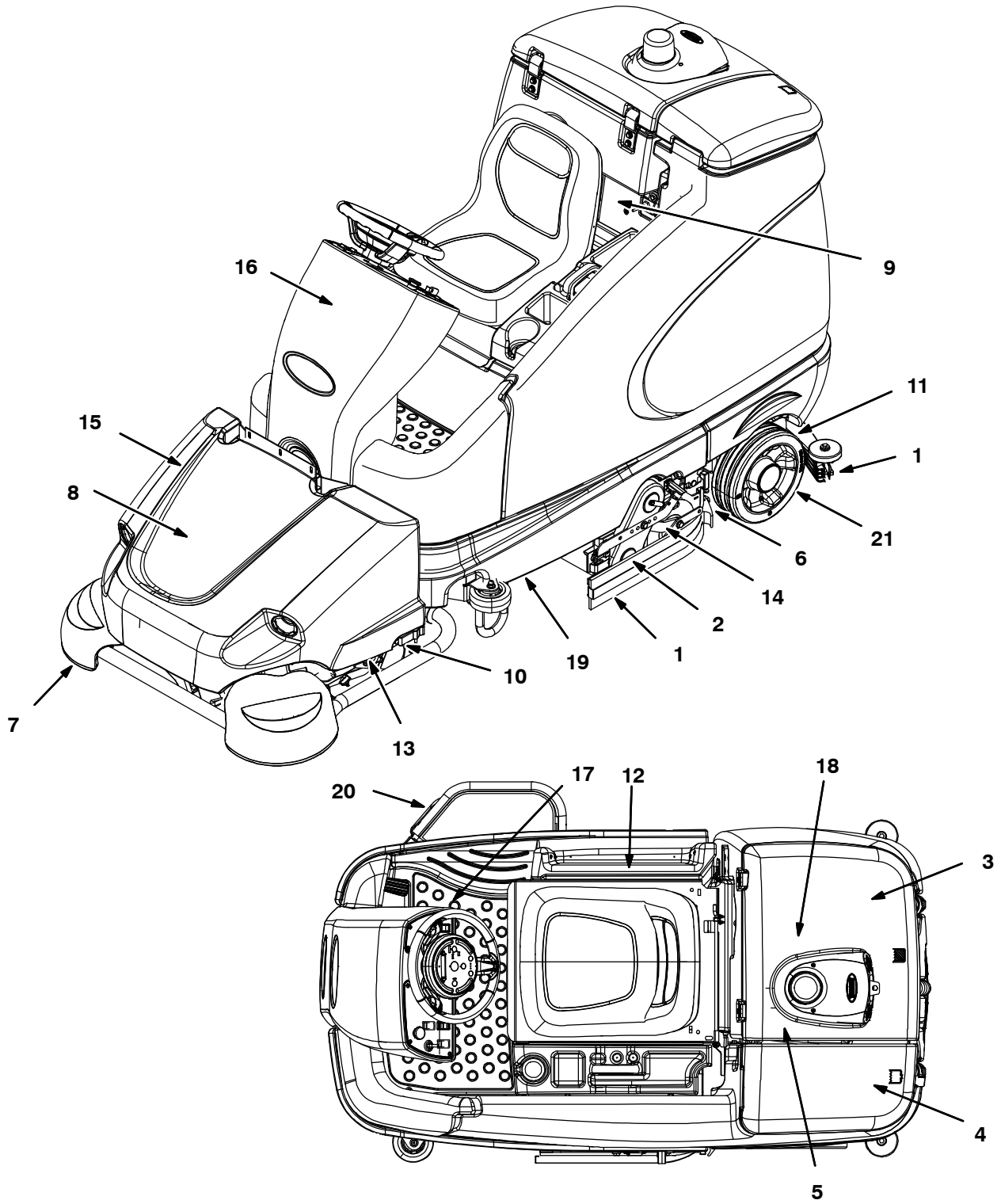

356071

MAINTENANCE CHART

The table below indicates the *Person Responsible* for each procedure.

O = Operator.

T = Trained Personnel.

Interval	Person Resp.	Key	Description	Procedure	Lubricant/ Fluid	No. of Service Points
Daily	O	1	Side and rear squeegees	Check for damage and wear	–	3
	O	2	Main brushes	Check for damage, wear, debris	–	2
	O	3	Recovery tank	Clean tank	–	1
	O	3	Recovery tank (ES only)	Clean ES filter	–	1
	O	4	Solution tank (ES only)	Clean solution supply filter	–	1
	O	5	Vacuum fan inlet filter	Clean	–	1
	O	6	Cylindrical brushes only: Debris tray	Clean	–	1
	O	7	Pre-Sweep side brushes	Check for damage, wear, debris	–	2
	O	10	Pre-Sweep main bush	Check for damage, wear, debris	–	1
	O	8	Pre-Sweep debris hopper	Clean	–	1
	O	20	Side brush	Check for damage, wear, debris	–	1
O	20	Side brush squeegee	Check for damage and wear	–	1	
Weekly	T	12	Battery cells	Check electrolyte level	DW	3
50 Hours	T	11	Squeegee caster wheel pivot points	Lubricate	SPL	4
	T	1	Side and rear squeegees	Check deflection and leveling	–	6
	O	13	Pre-Sweep skirts and seals	Check for damage and wear	–	4
	O	2	Main brushes (cylindrical)	Rotate brushes from front to rear	–	2
	O	9	FaST/Solution filter screen	Clean	–	1
200 Hours	T	12	Battery terminals and cables	Check and clean	–	12
	T	14	Cylindrical brush drive belts	Check for damage and wear	–	2
	T	15	Pre-Sweep brush drive belt	Check for damage and wear	–	2
	T	17	Steering chain	Lubricate, check tension, and check for damage and wear.	GL	1

MAINTENANCE

The table below indicates the *Person Responsible* for each procedure.

O = Operator.

T = Trained Personnel.

Interval	Person Resp.	Key	Description	Procedure	Lubricant/ Fluid	No. of Service Points
500 Hours	T	18	Vacuum fan motor(s)	Check motor brushes	–	1 (2)
	O	21	Tires	Check for damage and wear	–	3
1000 Hours	T	14	Main brush motors	Check motor brushes (Check every 100 hours after initial 1000 hour check)	–	2 (4)
	T	20	Side brush motor	Check motor brushes (Check every 100 hours after initial 1000 hour check)	–	1
	T	13	Pre-Sweep main brush motor	Check motor brushes (Check every 100 hours after initial 1000 hour check)	–	1
	T	9	FaST injector filters	Replace	–	1

LUBRICANT/FLUID

DW . . . Distilled water.

SPL . . . Special lubricant, Lubriplate EMB grease (Tennant part number 01433-1)

GL . . . SAE 90 weight gear lubricant

NOTE: More frequent maintenance intervals may be required in extremely dusty conditions.

YELLOW TOUCH POINTS

This machine features easy to find yellow touch points for simple service items. No tools are required to perform these maintenance operations,



LUBRICATION

FOR SAFETY: Before leaving or servicing machine, stop on level surface, turn off machine, and remove key.

STEERING CHAIN

The steering chain is located on the steering column directly under the control panel. Check for damage or wear and lubricate the steering chain after every 200 hours.

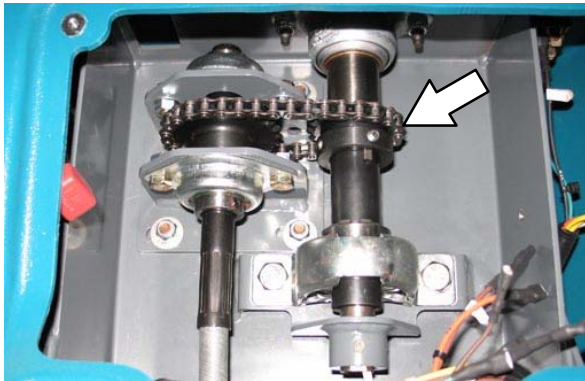
**STEERING GEAR CHAIN**

The steering gear chain is located directly above the front tire. Check for damage or wear and lubricate the steering gear chain after every 200 hours.

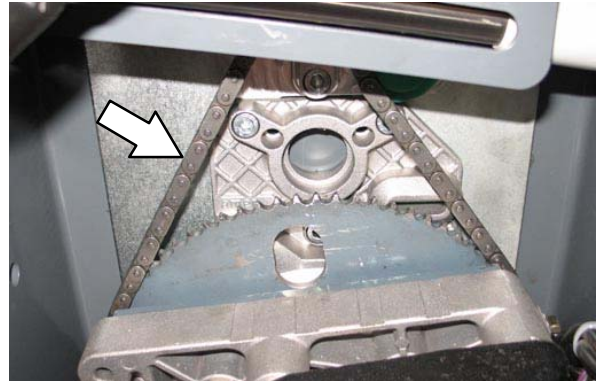
**REAR SQUEEGEE CASTERS**

Lubricate the rear squeegee caster pivot point on each squeegee caster after every 50 hours.

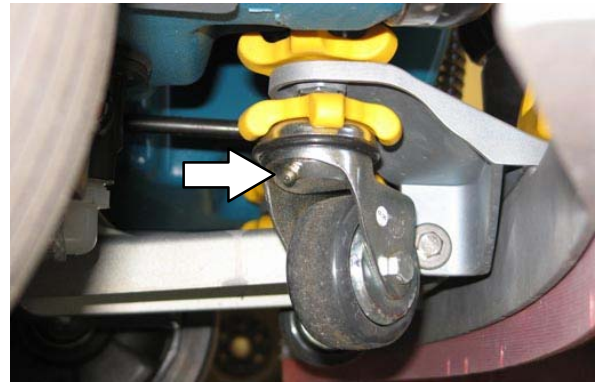

MAINTENANCE

BATTERIES

FOR SAFETY: Before leaving or servicing machine, stop on level surface, turn off machine, set parking brake (if equipped), and remove key.

The lifetime of the batteries depends on their proper maintenance. To get the most life from the batteries;

- Do not charge the batteries more than once a day and only after running the machine for a minimum of 15 minutes.
- Do not leave the batteries partially discharged for long period of time.
- Only charge the batteries in a well-ventilated area to prevent gas build up. Charge batteries in areas with ambient temperatures 27°C (80°F) or less.
- Allow the charger to complete charging the batteries before re-using the machine.
- Maintain the proper electrolyte levels of flooded (wet) batteries by checking levels weekly.

CHECKING THE ELECTROLYTE LEVEL

The flooded (wet) lead-acid batteries require routine maintenance as described below. Check the battery electrolyte level weekly.

NOTE: Do Not check the electrolyte level if the machine is equipped with the battery watering system. Proceed to the BATTERY WATERING SYSTEM (OPTION).

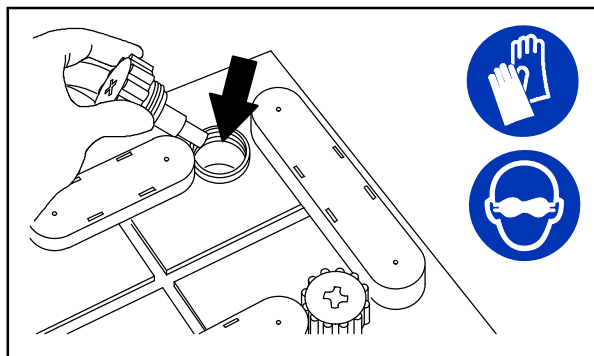

FOR SAFETY: When servicing machine, keep all metal objects off batteries. Avoid contact with battery acid.

The level should be slightly above the battery plates as shown before charging. Add distilled water if low. **DO NOT OVERFILL.** The electrolyte will expand and may overflow when charging. After charging, distilled water can be added up to about 3 mm (0.12 in) below the sight tubes.

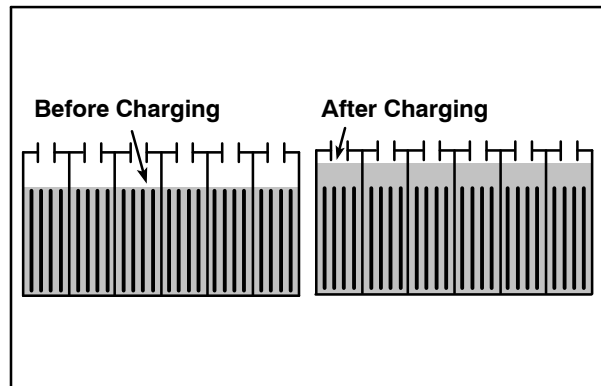

NOTE: Make sure the battery caps are in place while charging. There may be a sulfur smell after charging batteries. This is normal.

MAINTENANCE-FREE BATTERIES

Maintenance-free batteries do not require watering. Cleaning and other routine maintenance is still required.

CHECKING CONNECTIONS / CLEANING

After every 200 hours of use check for loose battery connections and clean the surface of the batteries, including terminals and cable clamps, with a strong solution of baking soda and water. Replace any worn or damaged wires. Do not remove battery caps when cleaning batteries.



CHARGING THE BATTERIES (OFF-BOARD CHARGER)

IMPORTANT: Before charging, make sure that the charger setting is properly set for the battery type.

1. Drive the machine to a flat, dry surface in a well-ventilated area.
2. Stop the machine and turn the machine power off.

FOR SAFETY: Before leaving or servicing machine, stop on level surface, turn off machine, and remove key.

3. Lift the operator seat open, engage the seat support bar, then remove the accessory box and tray.

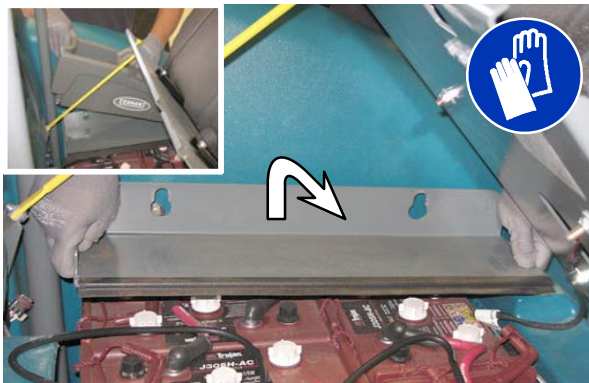

NOTE: Make sure the batteries have the proper electrolyte level before charging. See *CHECKING THE ELECTROLYTE LEVEL*.

4. Plug the charger AC power supply cord into a properly grounded outlet.

5. Plug the charger connector into the remote battery charge connector.

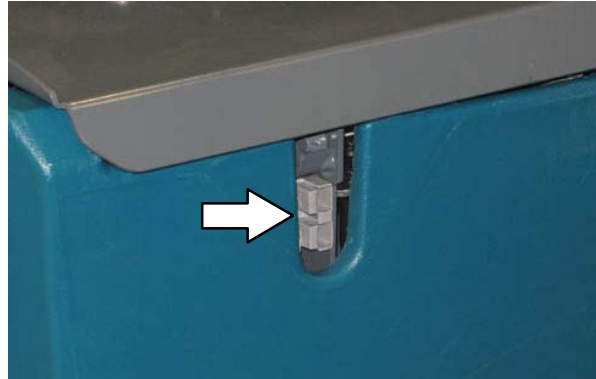

WARNING: Batteries emit hydrogen gas. Explosion or fire can result. Keep sparks and open flame away. Keep covers open when charging.

NOTE: If the charger "FAULT CODE" lights flash when the batteries are plugged into the charger, refer to the charger manufacturer manual for fault code definitions.

6. The Tennant charger will start automatically. When the batteries are fully charged, the Tennant charger will automatically turn off.
7. After the charger has turned off, unplug the charger connector from the remote battery charge connector.

ATTENTION: Do not disconnect the charger DC cord from the machine receptacle when the charger is operating. Arcing may result. If the charger must be interrupted during charging, disconnect the AC power supply cord first.

8. Close the operator seat.

MAINTENANCE

CHARGING THE BATTERIES (ON-BOARD CHARGER)

IMPORTANT: Before charging, make sure that the charger setting is properly set for the battery type.

1. Drive the machine to a flat, dry surface in a well-ventilated area.
2. Stop the machine and turn the machine power off.

FOR SAFETY: Before leaving or servicing machine, stop on level surface, turn off machine, and remove key.

3. Lift the operator seat open, engage the seat support bar, then remove the accessory box and tray.

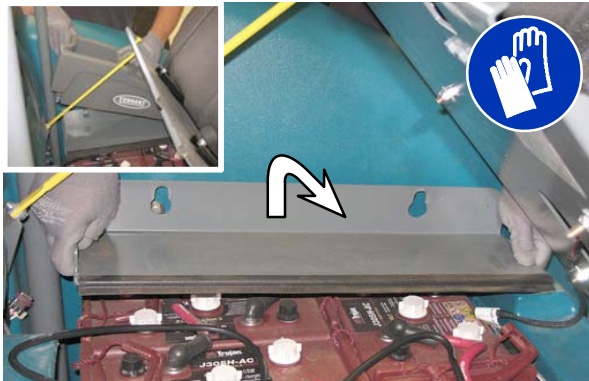

NOTE: Make sure the batteries have the proper electrolyte level before charging. See *CHECKING THE ELECTROLYTE LEVEL*.

4. Plug the on-board battery charger cord into a properly grounded wall outlet.

WARNING: Batteries emit hydrogen gas. Explosion or fire can result. Keep sparks and open flame away. Keep covers open when charging.

NOTE: The machine will not operate when charging.

5. The on-board charger will start charging the batteries. Once the charging cycle begins, the indicator lights will progress from red, yellow to green. When the green indicator light stays on, the charging cycle is done.



If the charger detects a problem, the charger will display an error code (See *ON-BOARD BATTERY CHARGER ERROR CODES*).

6. Unplug the on-board battery charger from the wall outlet and neatly stow the cord inside the battery compartment.
7. Close the operator seat.

ON-BOARD BATTERY CHARGER ERROR CODES

Display Code	Fault	Solution
bat	Loose or damaged battery cable.	Check battery cable connection.
	Battery exceeded maximum voltage level.	No action necessary.
E01	Exceeded maximum battery voltage allowed. Interrupts charging cycle.	No action necessary.
E02	Safety thermostat exceeded maximum internal temperature. Interrupts charging cycle.	Ensure the charger vents are not obstructed. Clear obstructions.
E03	Exceeded maximum time for charging phase, leaving the batteries undercharged due to a sulfated or faulty battery. Interrupts charging cycle.	Repeat the charging cycle. If the error code E03 reappears check battery or replace it.
SCt	Safety timer exceeded maximum charging time. Interrupts charging cycle.	Replace battery.
Srt	Possible internal short circuit.	Contact a Tennant service representative.

MAINTENANCE

ON-BOARD CHARGER SETTINGS

If the machine is equipped with the on-board charger, the charger settings are properly set at the factory. If different batteries are put in the machine, the settings must be changed to match the new battery type before charging. Failure to properly set the charger will result in battery damage.

Refer to the battery label for the battery type. Contact the battery manufacturer if battery is not labeled.

To verify the setting of the charger, connect the charger cord into an electrical outlet. The charger will display a sequence of the following codes (three-digits + the code) when the cord is connected:

- A = Charging current
- U = Battery Voltage
- h = Charging time
- C = Charging ampere-hours [Ah]
- E = Energy used [Kwh]
- "GEL" or "Acd" = Battery type for which the charger is currently set. Before charging make sure battery type matches the display: GEL=Sealed, Acd=WET (lead acid).

Press the arrow button to review the codes. Refer to the battery type code to determine the charger battery type setting.

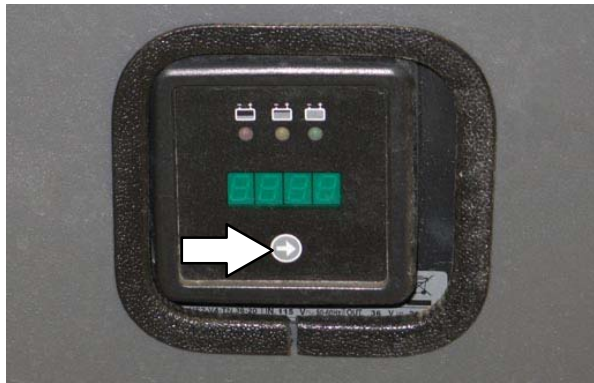

To change the setting, unplug the charger and peel up the corner of the display label to access the switches. The charger cord must be unplugged when resetting.



Adjust the switches to the correct setting for the batteries.

Lead Acid 240Ah:

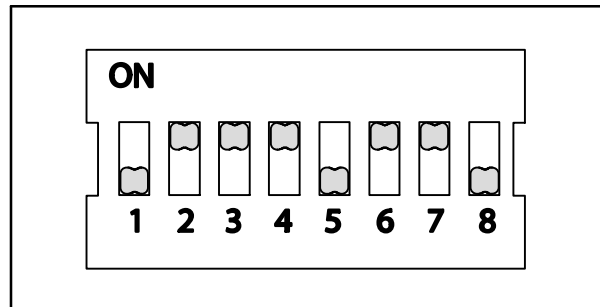

Lead Acid 360Ah:

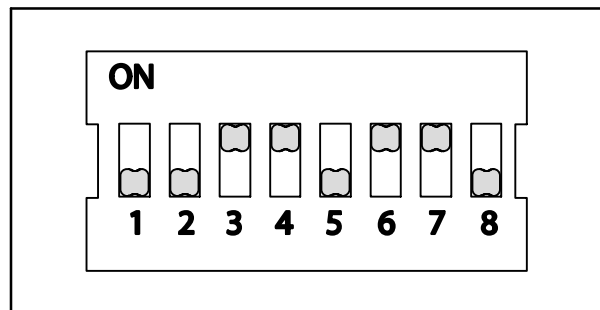

Gel:

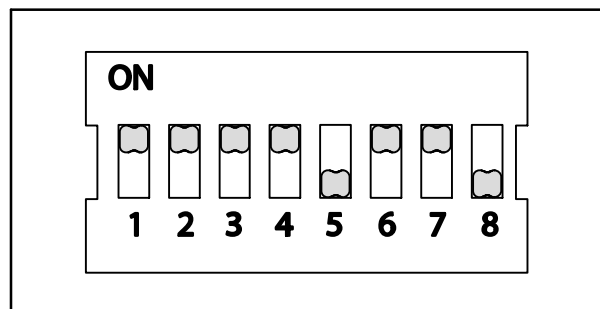

CHANGING THE ON-BOARD BATTERY CHARGER FUSE

FOR SAFETY: Before leaving or servicing machine, stop on level surface, turn off machine, and remove key.

A 15 Amp fuse protects the on-board charger. Follow the instructions below to replace a blown fuse. Never substitute a higher Amp rated fuse than specified.

1. Lift the operator seat open, engage the seat support bar, then remove the accessory box and tray.

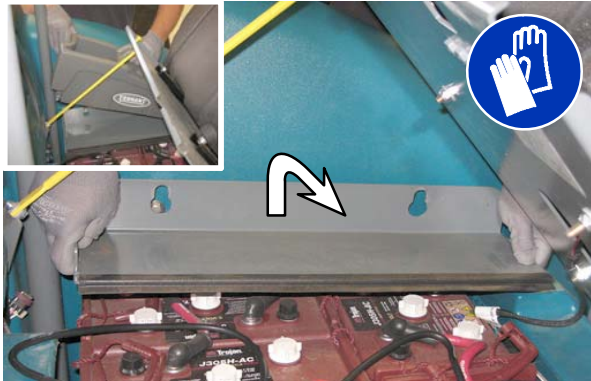

2. Unplug the charger AC power supply cord from the wall outlet.

WARNING: Electrical Hazard. Unplug charger before servicing machine.

3. Disconnect the battery cables from the batteries.

FOR SAFETY: When servicing machine, disconnect battery connection before working on machine.

4. Remove the hardware holding the side panel to the machine and remove the side panel from the machine.

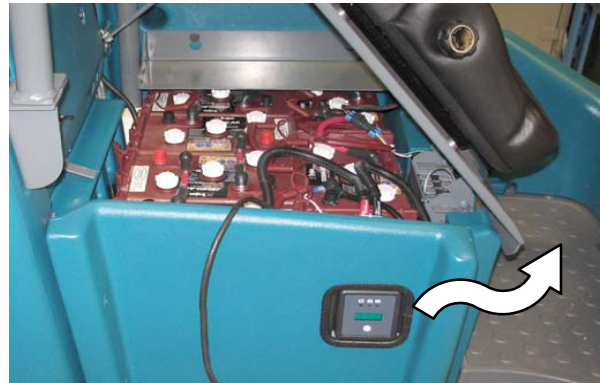
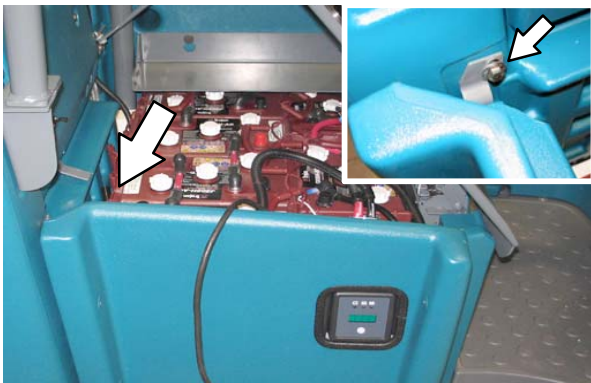

5. Remove the hardware holding the on-board battery charger onto the machine

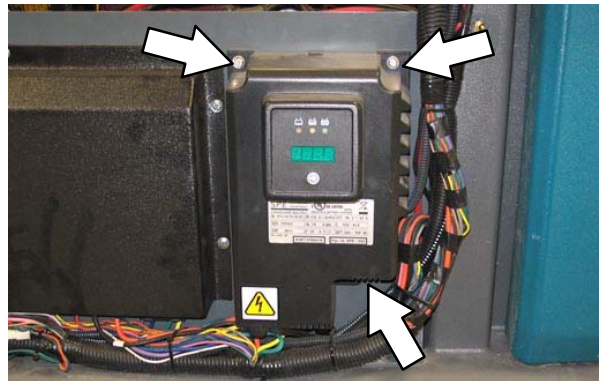

6. Carefully pull the on-board charger out to access the fuse.

7. Remove the fuse cap and replace the fuse.



8. Reinstall the on-board battery charger and side panel onto the machine.

MAINTENANCE

FLOW-RITE™ BATTERY WATERING SYSTEM (OPTION)

The optional Flow-Rite battery watering system provides a safe and easy way to maintain the proper electrolyte levels in the batteries.

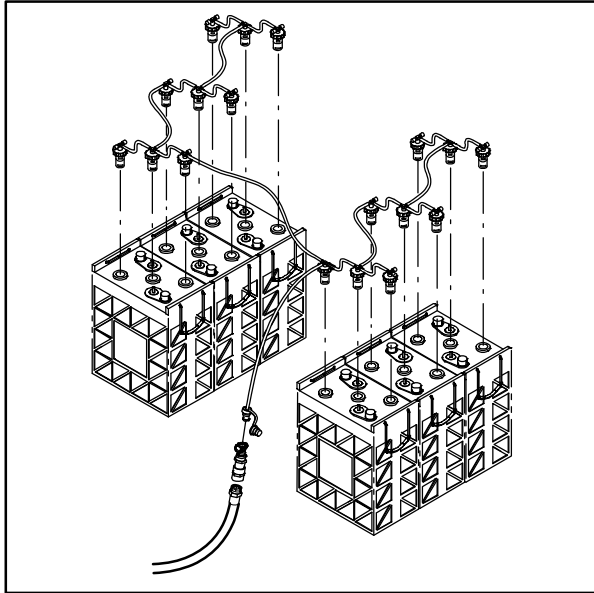

Check the battery watering system hoses and connections for damage or wear after every 100 hours.

FOR SAFETY: Before leaving or servicing machine, stop on level surface, turn off machine, and remove key.

1. Lift the operator seat open and engage the seat support.
2. Fully charge batteries prior to using the battery watering system. Do not add water to batteries before charging, the electrolyte level will expand and may overflow when charging. See *CHARGING THE BATTERIES (OFF-BOARD CHARGER)* or *CHARGING THE BATTERIES (ON-BOARD CHARGER)*.

3. Connect the water supply hose to the fill regulator.

NOTE: Water quality is important to maintain the life of the battery. Always use water that meets battery manufacturer requirements.



NOTE: The water supply to the battery watering system must always be 7.57 LPM (2 GPM) or more. Use the purger to confirm the water supply pressure. Refer to Flow-Rite Operator Manual for additional information.



4. Remove the dust cover from the battery fill tube and connect the fill regulator.



5. Turn on the water supply. The red balls inside the flow indicator will spin. The red balls stop spinning when the batteries are full.

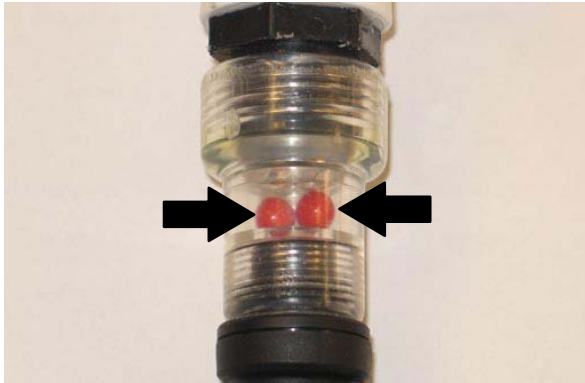

6. Disconnect the battery fill tube from the fill regulator.
7. Turn off the water supply.
8. After adding water, replace the dust cap on the battery fill hose and return the fill regulator to the storage location for future use.

MAINTENANCE

HYDROLINK® BATTERY WATERING SYSTEM (OPTION)

The following instructions are for models equipped with the HydroLINK battery watering system option.

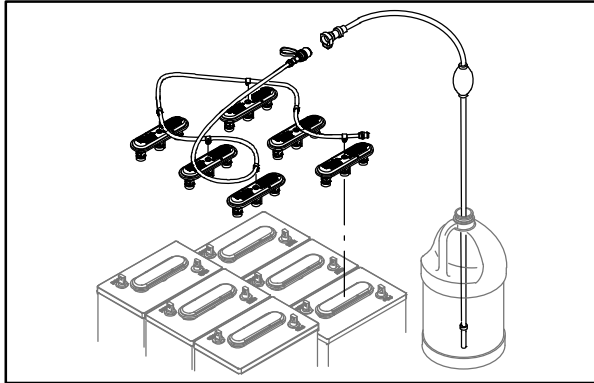

The optional HydroLINK battery watering system provides a safe and easy way to maintain the proper electrolyte levels in your batteries. It is designed exclusively for Trojan® wet/lead-acid batteries.

Check the battery watering system hoses and connections for damage or wear after every 100 hours.

FOR SAFETY: Before leaving or servicing machine, stop on level surface, turn off machine, and remove key.

1. Lift the operator seat open and engage the seat support.
2. Fully charge batteries prior to using the battery watering system. Do not add water to batteries before charging, the electrolyte level will expand and may overflow when charging. See *CHARGING THE BATTERIES (OFF-BOARD CHARGER)* or *CHARGING THE BATTERIES (ON-BOARD CHARGER)*.

3. After charging batteries, check the battery electrolyte level indicators located on the battery covers. If the level indicator is white add water as described in the following instructions. If the level indicators are black the electrolyte is at the correct level, no water is required.

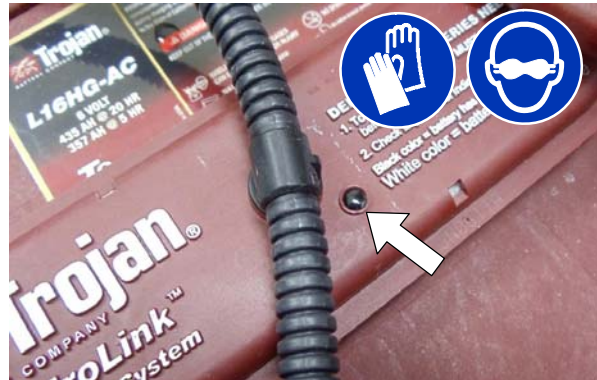

4. Locate the battery fill hose coupler inside the battery compartment. Remove the dust cap and connect the hand pump hose.

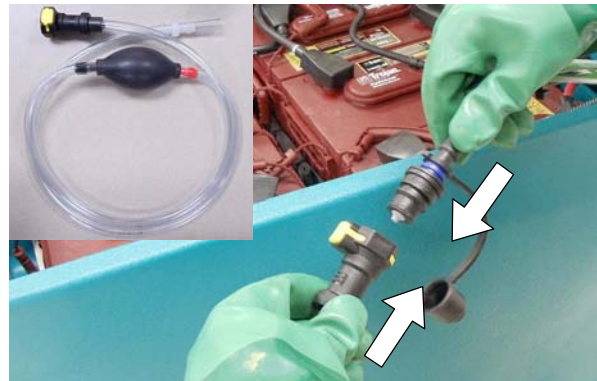

5. Submerge the other end of the hand pump hose into a bottle of distilled water.



6. Squeeze the bulb on the hand pump hose until firm. The level indicators will turn black when full.

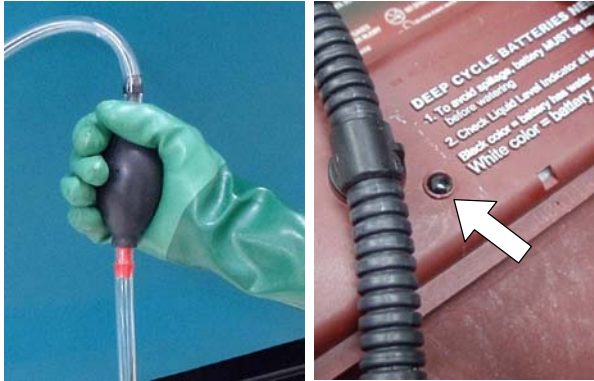

7. After adding water, replace the dust cap on the battery fill hose and store the hand pump hose inside the machine's battery compartment for future use.

MAINTENANCE

CIRCUIT BREAKERS

Circuit breakers are resettable electrical circuit protection devices designed to stop the flow of current in the event of a circuit overload. Once a circuit breaker is tripped, reset it manually by pressing the reset button after the breaker has cooled down.

Circuit breakers 1 through 10 are located in the front of the battery compartment.

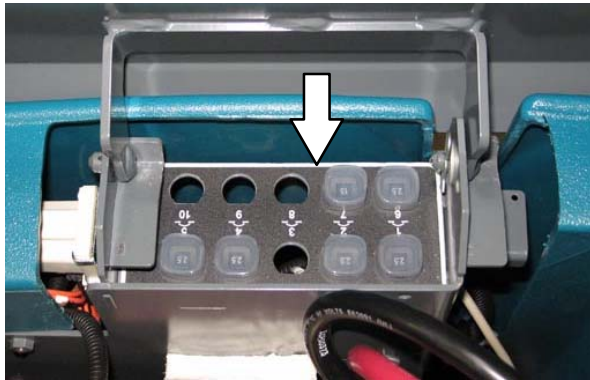

Circuit breakers 11 through 19 are located on the electrical panel.

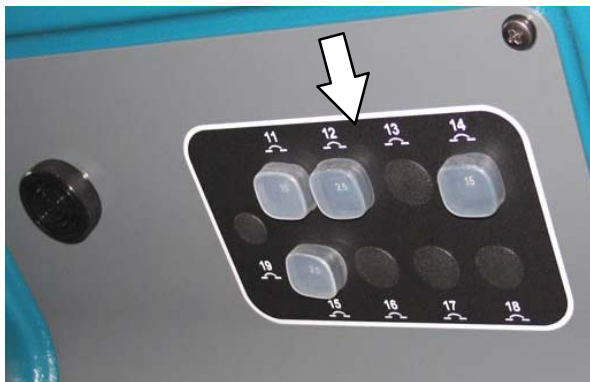

Circuit breaker 20 is located inside the optional light assembly mounted on top of the recovery tank.

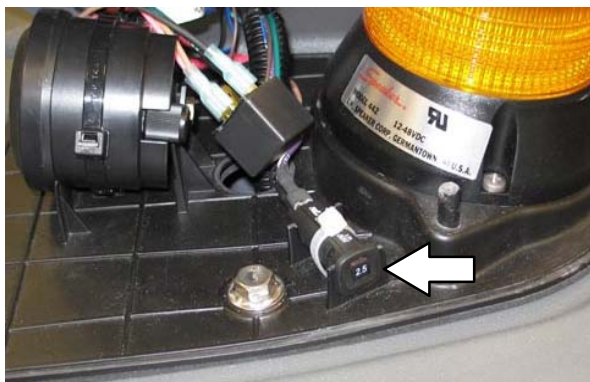

If the overload that caused the circuit breaker to trip is still present, the circuit breaker will continue to stop current flow until the problem is corrected.

The chart below shows the circuit breakers and the electrical components they protect.

Circuit Breaker	Rating	Circuit Protected
CB1	2.5 A	Start
CB2	2.5 A	Key switch
CB3	2.5 A	Sweep controls (Option)
CB4	2.5 A	Main water, FaST, ES, Horn
CB5	2.5 A	Detergent meter (Option)
CB6	2.5 A	Side brush (Option)
CB7	15 A	FaST ./ ES pump (Option)
CB8	20 A	Sweep brushes (Option)
CB9	2.5 A	ec-H2O (Option)
CB10	2.5 A	ec-H2O pump (Option)
CB11	15 A	Lights (Option)
CB12	2.5 A	Headlight / Tail lights (Option)
CB13	2.5 A	Overhead guard warning light (Option)
CB14	15 A	Spray Nozzle (Option)
CB15	2.5 A	Warning lights (Option)
CB16	15 A	Pre-Sweep (Option)
CB17	Open	Extra for Specials
CB18	Open	Extra for Specials
CB19	25 A	Sweep vacuum fans (Option)
CB20	25 A	Reverse alarm light (Option)

ELECTRIC MOTORS

Inspect the carbon brushes on the vacuum fan motor after every 500 hours of operation. Inspect the carbon brushes on the main brush motors, Pre-Sweep main brush motor, and side brush motors after the first 1000 hours of operation and every 100 hours after the initial check. Refer to the table below for carbon brush inspection intervals.

Carbon Brush Inspection	Hours
Main Brush Motors	1000*
Pre-Sweep Main Brush Motors	1000*
Side Brush Motor (Option)	1000*
Vacuum Motor	500

**Inspect carbon brushes every 100 hours after the initial 1000 hour change.*

SCRUB BRUSHES

The machine can be equipped with either *disk* or *cylindrical* scrub brushes. Check scrub brushes daily for wire or string tangled around the brush or brush drive hub. Also check brushes or pads for damage and wear.

DISK BRUSHES AND PADS

Replace the pads when they no longer clean effectively. Replace the brushes when they no longer clean effectively or when the bristles are worn down to the yellow indicators.

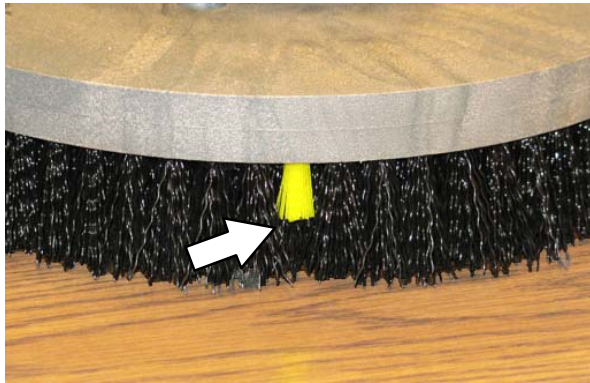

Cleaning pads must be placed on pad drivers before they are ready to use. The cleaning pad is held in place with a center disk. Both sides of the pad can be used for scrubbing. Turn the pad over to use the other side.

Cleaning pads need to be cleaned immediately after use with soap and water. Do not wash the pads with a pressure washer. Hang pads, or lay pads flat to dry.

NOTE: Always replace brushes and pads in sets. Otherwise one brush or pad will be more aggressive than the other.

REPLACING DISK BRUSHES OR PAD DRIVERS

1. Raise the scrub head.
2. Turn off the machine.

FOR SAFETY: Before leaving or servicing machine, stop on level surface, turn off machine, and remove key.

3. Open the left side squeegee support door.

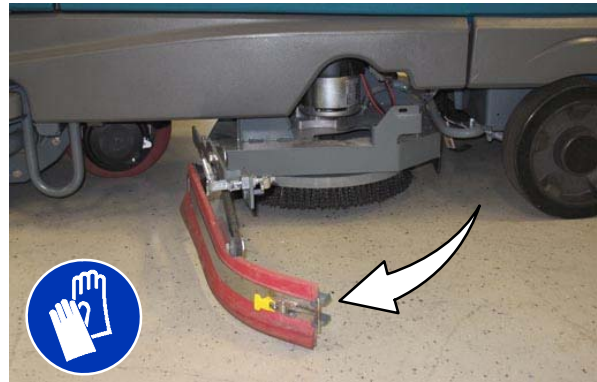

4. Turn the brushes until the spring handles are visible.

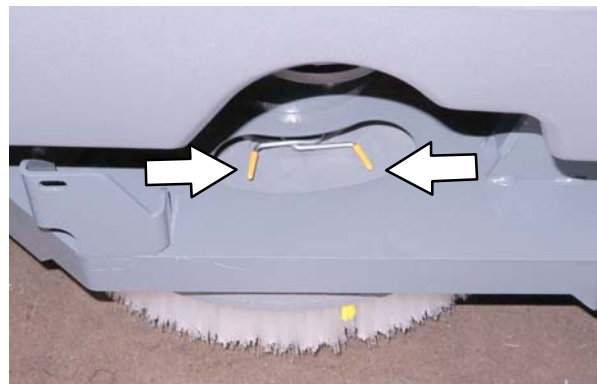

5. Squeeze the spring handles and let the brushes drop to the floor. Remove the brush from under the scrub head.

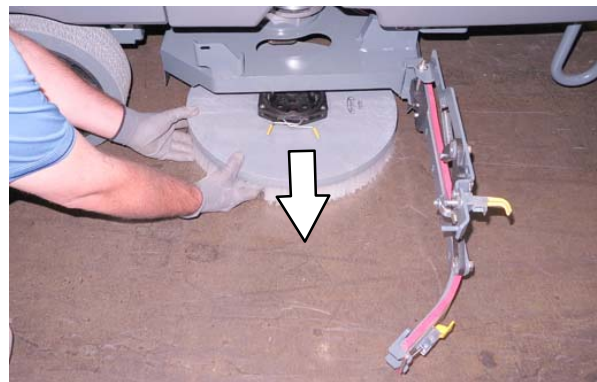

MAINTENANCE

6. Set the brush spring open on the new brush to make the brush installation easier.



7. Push the new brush under the scrub head, align the brush drive socket with the brush drive hub, and lift the brush up onto the brush drive hub until the brush locks onto the hub.

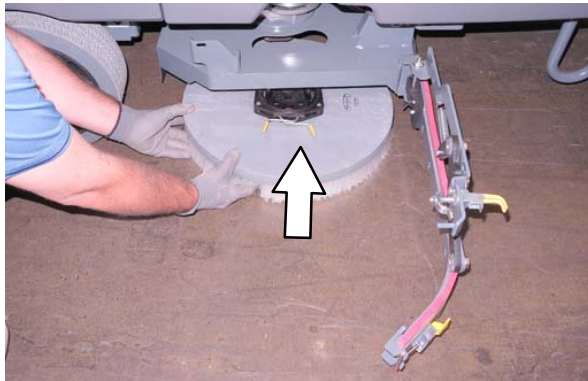

8. Ensure the brush is securely mounted on the brush drive hub.
9. Close and secure the left side squeegee assembly.
10. Repeat procedure for the other brush.

REPLACING DISK SCRUB PADS

1. Remove the pad driver from the machine.
2. Squeeze the spring clip together and remove the center disk from the pad driver.



3. Remove the scrub pad from the pad driver.



4. Flip or replace the scrub pad. Center the scrub pad on the pad driver and reinstall the center disk to secure the pad in place on the pad driver.
5. Reinstall the pad driver onto the machine.

CYLINDRICAL BRUSHES

Rotate the brushes from front-to-rear after every 50 hours of operation.

Replace the brushes when they no longer clean effectively.

NOTE: Replace worn brushes in pairs. Scrubbing with brushes of unequal bristle length will result in diminished scrubbing performance.

REPLACING CYLINDRICAL SCRUB BRUSHES

FOR SAFETY: Before leaving or servicing machine, stop on level surface, turn off machine, and remove key.

1. Open the side squeegee support door.
2. Lift the idler plate retainer handle and unhook the retainer ring from the idler plate hook.



3. Remove the idler plate from the scrub head.



4. Remove the brush from the scrub head



5. Position the brush with the *double row end* towards the scrub head opening. Guide the new brush onto the drive hub.
6. If rotating the brushes, always rotate the front with the back so that they wear evenly. They may be rotated end for end as well.

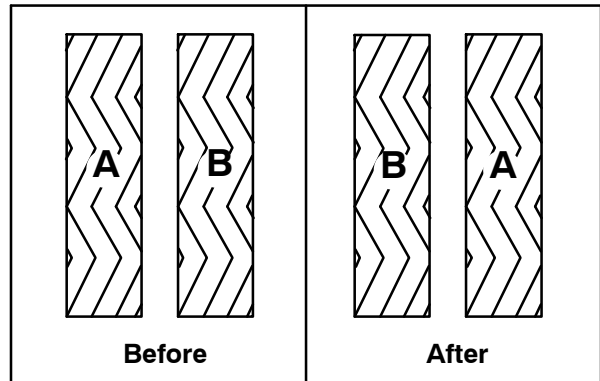

7. Reinstall the idler plate onto the scrub head and secure the idler plate into place with the idler plate retainer.
8. Repeat for the other brush on the other side of the scrub head.

NOTE: Do not switch the left or right idler plates or the brushes will need to be readjusted by trained personnel.

MAINTENANCE

SIDE BRUSH (OPTION)

Check the side brush daily for wear or damage. Remove any tangled string or wire from the side brush or side brush drive hub.

REPLACING THE SIDE BRUSH

Replace the pads when they no longer clean effectively. Replace the brushes when they no longer clean effectively or when the bristles are worn down to the yellow indicators.

1. Start the machine and press the side brush switch.
2. Shut off the machine after the side brush rotates from under the side guard, but before the side brush assembly lowers to the floor.



FOR SAFETY: Before leaving or servicing machine, stop on level surface, turn off machine, and remove key.

3. Remove the knobs holding the side brush squeegee assembly to the machine and remove the squeegee assembly from the machine.

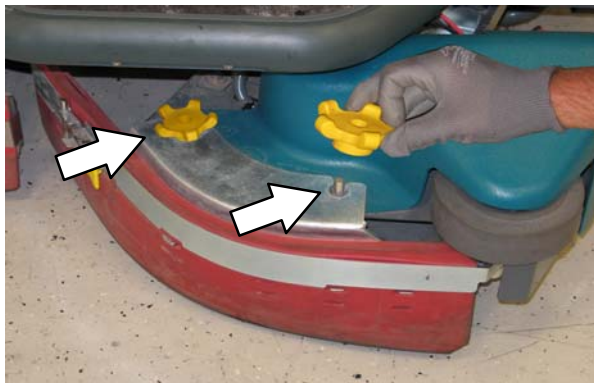

4. Squeeze the spring handles and let the side brush drop to the floor.

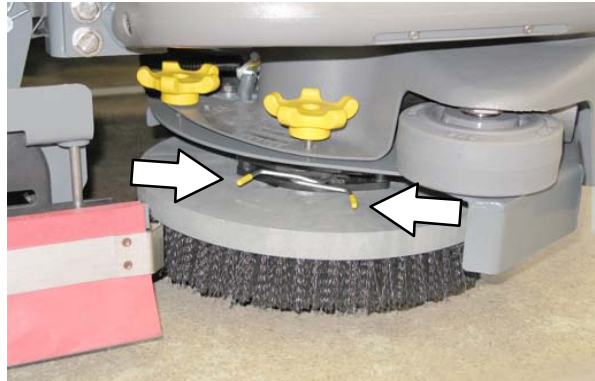

5. Remove the side brush from under the side brush assembly.
6. Set the brush spring open on the new brush to make the brush installation easier.



7. Place the new side brush underneath the side brush assembly and lift the side brush up onto the side brush hub until the brush locks onto the hub.
8. Reinstall the side brush squeegee assembly onto the side brush assembly.

PRE-SWEEP BRUSHES

The Pre-Sweep assembly is equipped with *disk* side brushes and a *cylindrical* main brush. Check the brushes daily for wire or string tangled around the brush or brush drive hub. Check the brushes daily for damage and wear.

REPLACING THE PRE-SWEEP DISK BRUSHES

Replace the brushes when they no longer clean effectively.

1. Turn on the machine.
2. Press the bottom of the Pre-Sweep switch to raise the Pre-Sweep assembly and stop sweeping.



3. Turn off the machine.

FOR SAFETY: Before leaving or servicing machine, stop on level surface, turn off machine, and remove key.

4. Reach into the center of the brush and pull the cotter pin from the hub assembly.

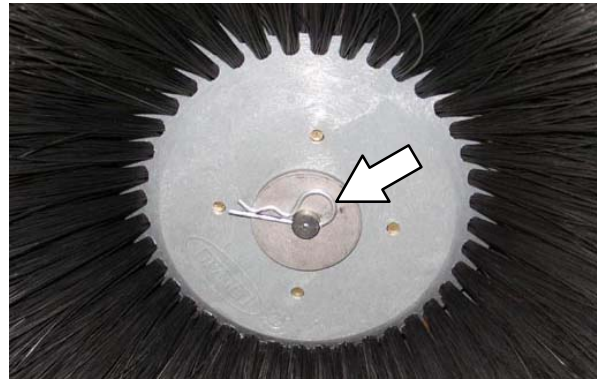

5. Remove the side brush from under the Pre-Sweep assembly.
6. Install the new side brush onto the Pre-Sweep side brush assembly.

MAINTENANCE

REPLACING THE PRE-SWEEP CYLINDRICAL BRUSH

Replace the brush when it no longer cleans effectively.

FOR SAFETY: Before leaving or servicing machine, stop on level surface, turn off machine, and remove key.

1. Turn off the machine.
2. Open the Pre-Sweep assembly cover and lock the cover open.
3. Loosen and remove the left brush arm knob.



4. Remove the left brush arm.



5. Remove the three knobs holding the Pre-Sweep side skirt and side skirt plate to the Pre-Sweep assembly.



6. Remove the side skirt plate and side skirt from the Pre-Sweep assembly.



7. Remove the cylindrical brush and replace with a new brush.



8. Guide the slotted end of the new brush onto the drive hub.
9. Reinstall the side skirt, side skirt plate, and left brush arm.

FaST SYSTEM

REPLACING THE FaST-PAK CARTON

FOR SAFETY: Before leaving or servicing machine, stop on level surface, turn off machine, and remove key.

1. Lift the operator seat open and engage the seat support bar.
2. Squeeze the button on the FaST supply hose connector, then pull the empty FaST-PAK carton out from the compartment and discard.



3. Remove the perforated knock outs from the new FaST-PAK carton. DO NOT remove the bag from the carton. Pull the hose connector from the bottom of the bag and remove the hose cap from the connector.

NOTE: The FaST-PAK Floor Cleaning Concentrate is specially designed for use with the FaST system scrubbing application. NEVER use a substitute. Other cleaning solutions may cause FaST system failure.

4. Slide the FaST-PAK carton into the FaST-PAK bracket.

5. Connect the FaST supply hose to the FaST-PAK hose connector.
6. Scrub with the FaST system for a few minutes to allow the detergent to reach maximum foaming.

CLEANING THE FaST SUPPLY HOSE CONNECTOR

Soak the connector in warm water if detergent buildup is visible. When a FaST-PAK carton is not installed, store the supply hose connector on the storing plug to prevent the hose from clogging.

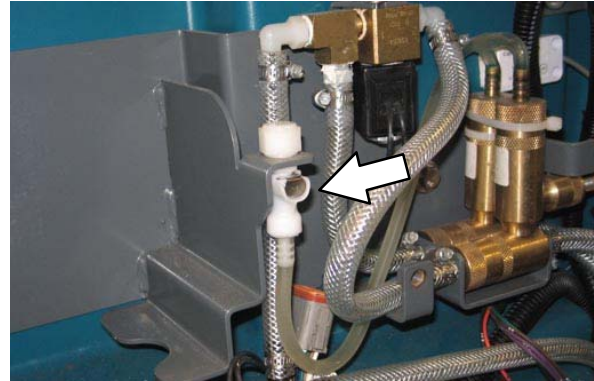

REPLACING THE FaST INJECTOR FILTERS

Replace the FaST injector filters after every 1000 hours of operation. Empty the solution tank before replacing the filters.

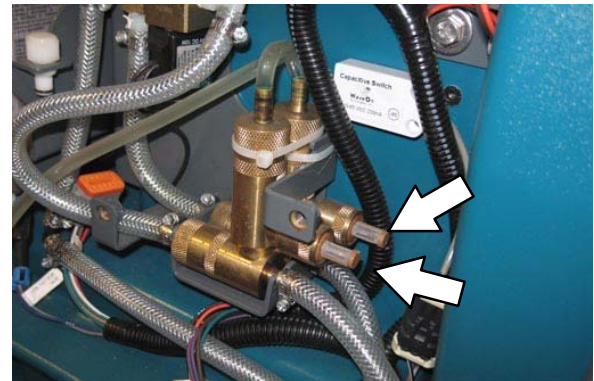

MAINTENANCE

ec-H2O MODULE FLUSH PROCEDURE

This procedure is only required when an alarm sounds and the *ec-H2O* system indicator light begins to blink.

FOR SAFETY: Before leaving or servicing machine, stop on level surface and turn off machine.

1. Lift the operator seat open and engage the seat support bar.
2. Remove the ec-H2O compartment cover.

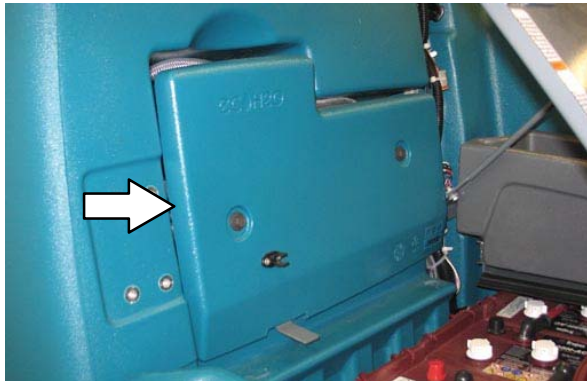

3. Remove the drain hose from the ec-H2O compartment.



4. Disconnect the outlet hose from the hose connected to the ec-H2O manifold.

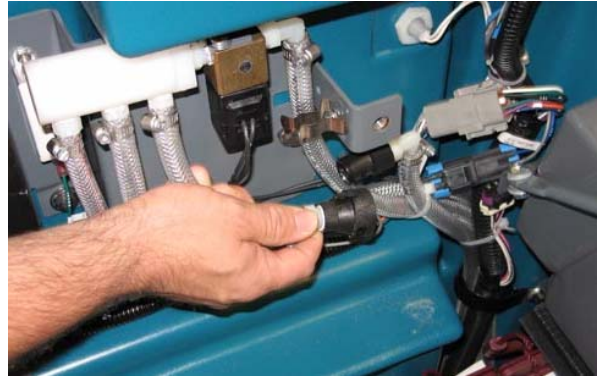

5. Connect the drain hose to the ec-H2O manifold hose disconnected from the outlet hose in the previous step.



6. Place the drain hose into a empty container.

7. Pour 2 gallons (7.6 liters) of white or rice vinegar into the solution tank.



8. Turn the key to the on (I) position.

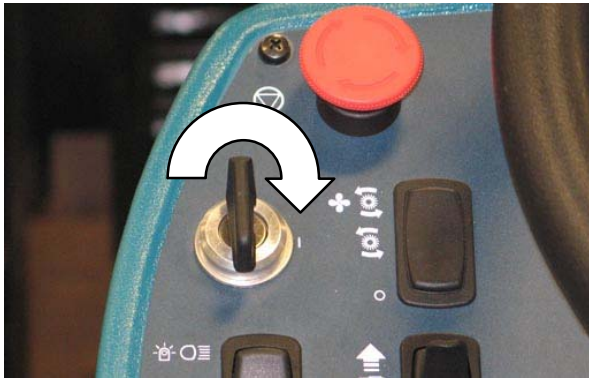

9. Press and release the ec-H₂O module flush switch to start the flush cycle.

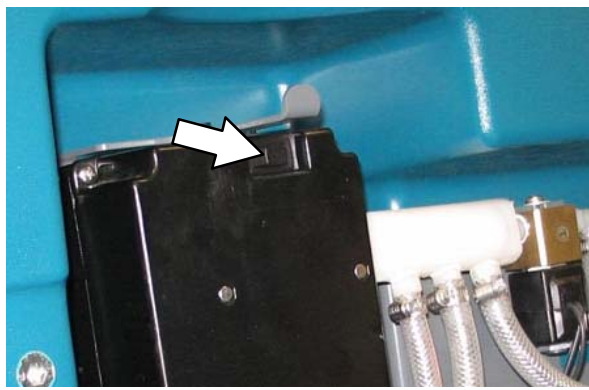

NOTE: The module will automatically shut off when the flush cycle is complete (approximately 7 minutes). The module must run the full 7 minute cycle in order to reset the system indicator light and alarm.

10. Pour 2 gallons (7.6 liters) of cool clean water into the solution tank.
11. Press and release the flush switch to rinse any remaining vinegar from the module. After 1–2 minutes, press the flush switch to turn off the module.
12. Disconnect the drain hose from the ec-H₂O manifold hose.
13. Reconnect the outlet hose to the the scrub head to the ec-H₂O manifold hose.
14. Place the drain hose back into the ec-H₂O compartment.
15. Reinstall the ec-H₂O compartment cover.
16. Close the operator seat cover.

SQUEEGEE BLADES

Check the squeegee blades for damage and wear daily. When the blades become worn, rotate the blades end-for-end or top-to-bottom to a new wiping edge. Replace blades when all edges are worn.

Check the deflection of the squeegee blades daily or when scrubbing a different type of surface. Check the leveling of the rear squeegee every 50 hours of operation.

REPLACING (OR ROTATING) THE REAR SQUEEGEE BLADES

1. Lower the scrub head.

FOR SAFETY: Before leaving or servicing machine, stop on level surface, turn off machine, and remove key.

2. Disconnect the vacuum hose from the rear squeegee assembly.



3. Loosen both squeegee mounting handles.

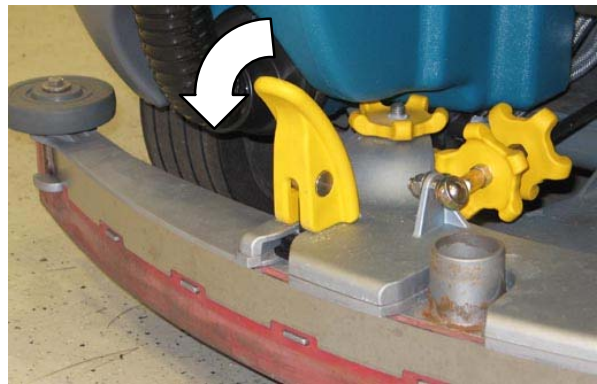
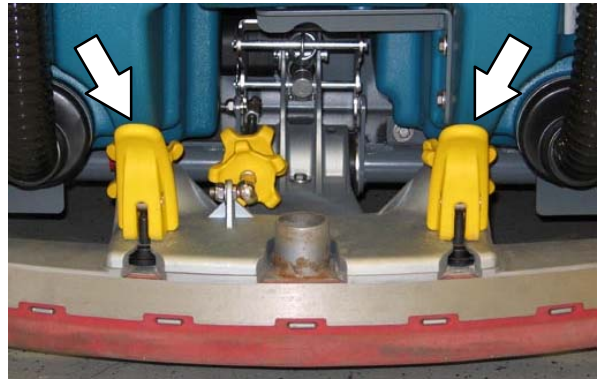

4. Pull the rear squeegee assembly from the machine.

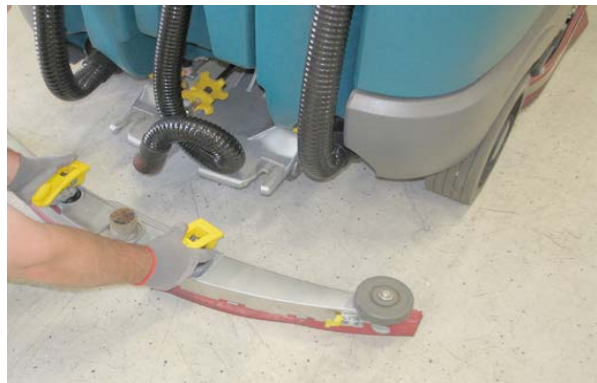

5. Loosen the retainer latch and remove the retainer from the squeegee assembly.



6. Remove the squeegee from the squeegee assembly.



7. Slide both retainers out away from the squeegee assembly.



8. Remove the inner frame from the outer frame.

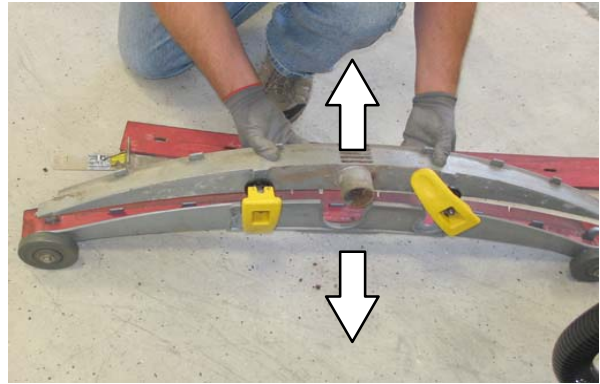

9. Remove the squeegee from the outer frame.



10. Install the rotated or new squeegee blade into the outer frame. Be sure the squeegee is completely slid down onto each tab on the outer frame.

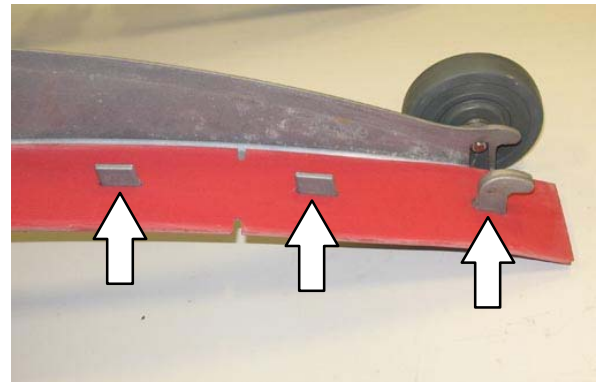

MAINTENANCE

11. Install the inner frame over the squeegee and onto the outer frame. Be sure the inner frame is tight against the top of the outer frame.

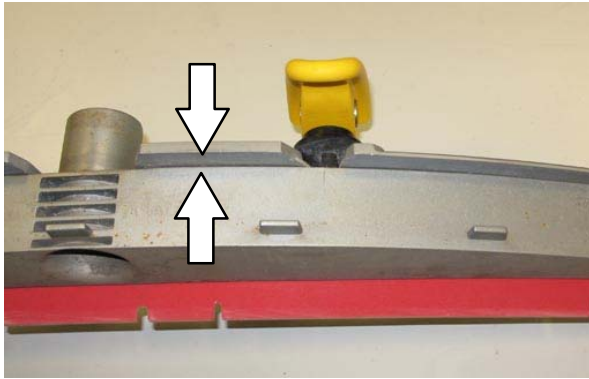

12. Slide both retainers into the squeegee assembly.



13. Place the rotated or new squeegee blade onto the inner frame. Be sure the squeegee is securely attached on each tab on the inner frame.

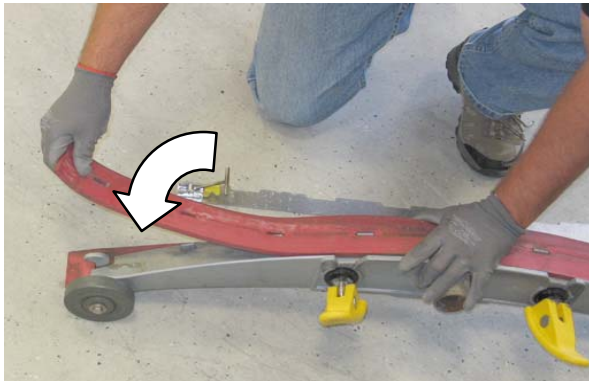

14. Insert the hinge end of the retainer into the hooks in the inner frame.

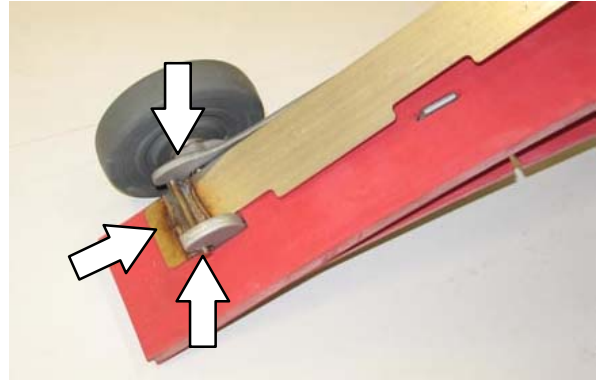

15. Install the retainer along the rest of the squeegee assembly and fasten the latch onto the other end of the squeegee assembly.

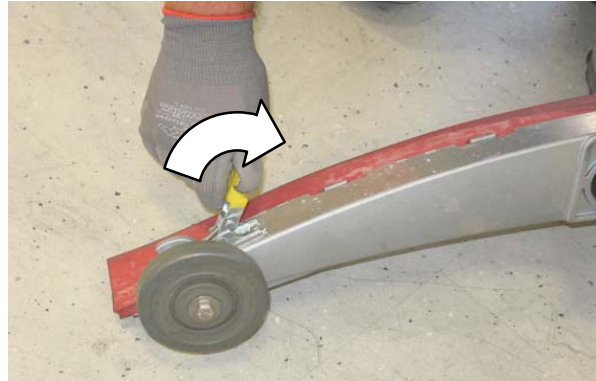

LEVELING THE REAR SQUEEGEE

Leveling the squeegee ensures the entire length of the squeegee blade is in even contact with the surface being scrubbed. Perform this adjustment on an even and level floor.

1. Lower the squeegee and drive the machine several meters (feet) forward and slowly bring the machine to a stop.

FOR SAFETY: Before leaving or servicing machine, stop on level surface, turn off machine, and remove key.

2. Check the squeegee deflection over the full length of the squeegee blade.
3. If the deflection is not the same over the full length of the blade, use the tilt adjust knob to make adjustments.

DO NOT disconnect the vacuum hose from the squeegee frame when leveling squeegee.

4. To adjust the squeegee leveling, loosen the tilt lock knob.

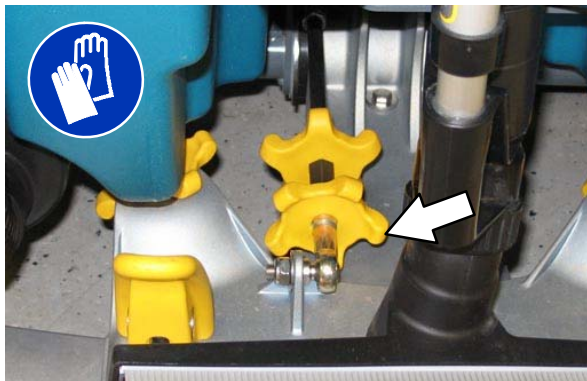

5. Turn the squeegee tilt adjust knob counter-clockwise to decrease the deflection at the ends of the squeegee blade.

Turn the squeegee tilt adjust knob clockwise to increase the deflection at the ends of the squeegee blade.

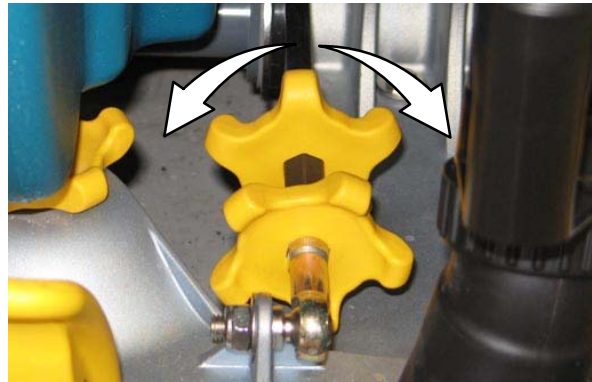

6. Tighten the tilt lock knob.
7. Drive the machine forward with the squeegee down to recheck the squeegee blade deflection if adjustments were made.
8. Readjust the squeegee blade deflection if necessary.

MAINTENANCE

ADJUSTING THE REAR SQUEEGEE BLADE DEFLECTION

Deflection is the amount of curl the overall squeegee blade has when the machine moves forward. The best deflection is when the squeegee wipes the floor dry with a minimal amount of deflection.

NOTE: Make sure the squeegee is level before adjusting the deflection. See LEVELING THE REAR SQUEEGEE.

1. Lower the squeegee and drive the machine several meters (feet) forward and slowly bring the machine to a stop.

FOR SAFETY: Before leaving or servicing machine, stop on level surface, turn off machine, and remove key.

2. Look at the amount of deflection or “curl” of the squeegee blade. The correct amount of deflection is 12 mm (0.50 in) for scrubbing smooth floors and 15 mm (0.62 in) for rough floors.

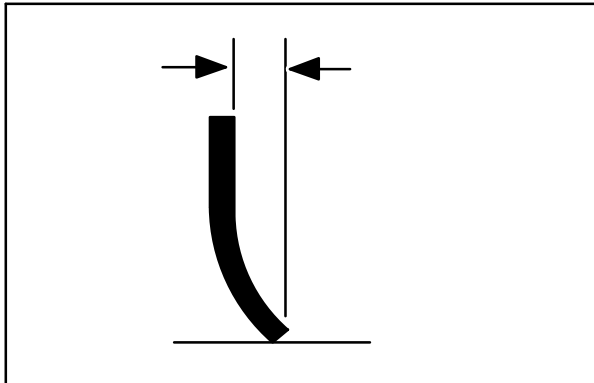

3. To adjust the overall squeegee blade deflection, loosen the lock knob.

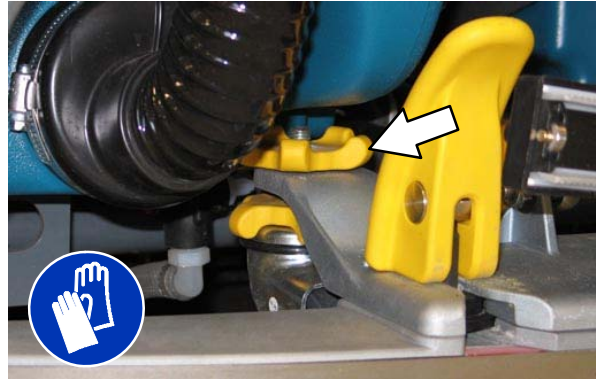

4. Turn the adjustment knobs counterclockwise to increase deflection or clockwise to decrease deflection.

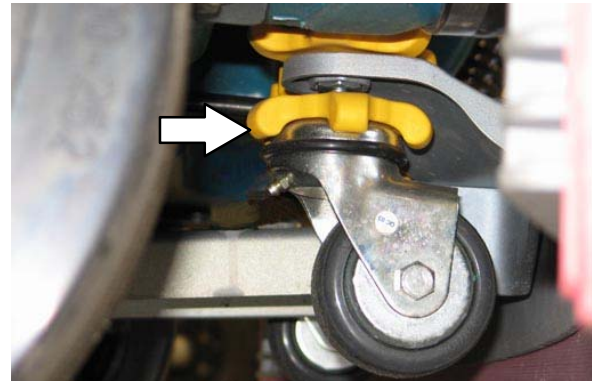

5. Retighten the lock knob.
6. Drive the machine forward again to recheck the squeegee blade deflection.
7. Readjust the squeegee blade deflection if necessary.

REPLACING OR ROTATING THE SIDE SQUEEGEE BLADES

1. If necessary, raise the scrub head.

FOR SAFETY: Before leaving or servicing machine, stop on level surface, turn off machine, and remove key.

2. Open the side squeegee support door.



3. Unhook the retaining band latch from the side squeegee assembly.

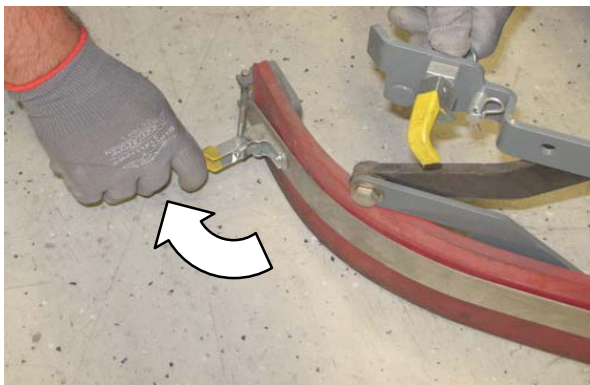

4. Remove the retaining band from the side squeegee assembly.

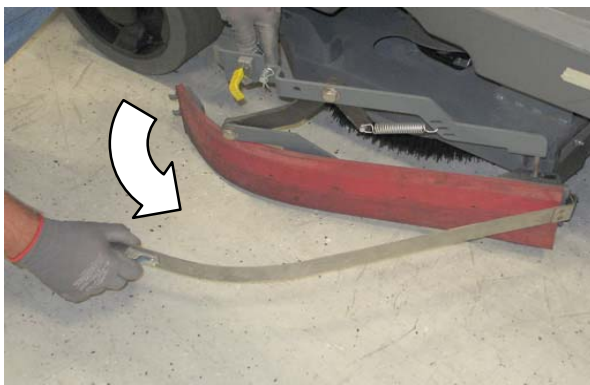

5. Remove the squeegee from the side squeegee assembly.

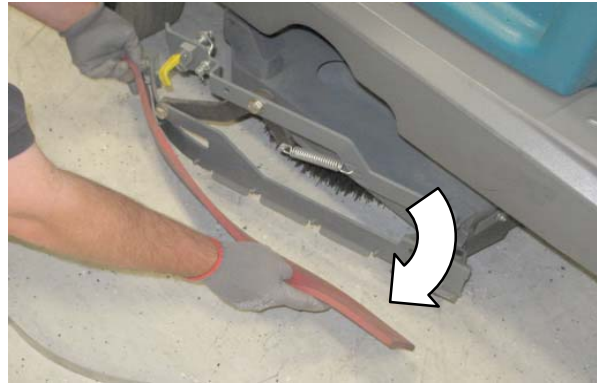

6. Install the rotated or new rear squeegee blade onto the side squeegee assembly.

7. Hook the retaining band onto the side squeegee assembly.

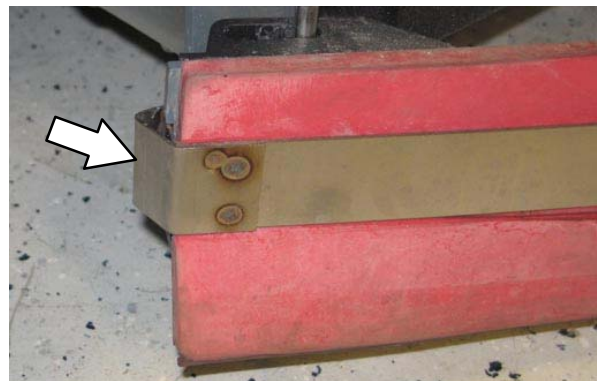

8. Fasten the retaining band latch onto the side squeegee assembly.

9. Repeat for the side squeegee on the other side of the scrub head.

MAINTENANCE

REPLACING OR ROTATING THE SIDE BRUSH SQUEEGEE BLADES (OPTION)

Check the side brush squeegee blade for damage and wear daily. Replace or rotate the blade if the leading edge is torn or worn half-way through the thickness of the blade.

1. Start the machine and press the side brush switch.
2. Shut off the machine after the side brush rotates from under the side guard, but before the side brush assembly lowers to the floor.



FOR SAFETY: Before leaving or servicing machine, stop on level surface, turn off machine, and remove key.

3. Remove the knobs holding the side brush squeegee assembly to the machine and remove the squeegee assembly.

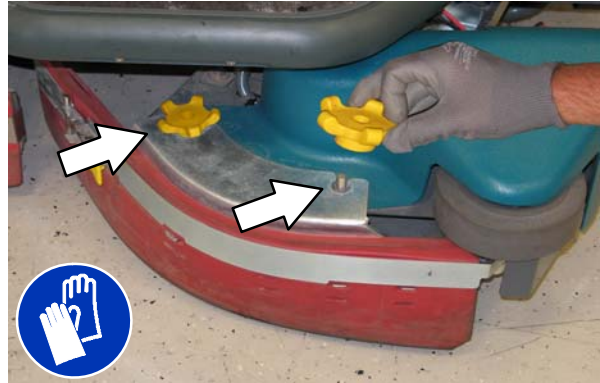

4. Loosen the retaining band latch.

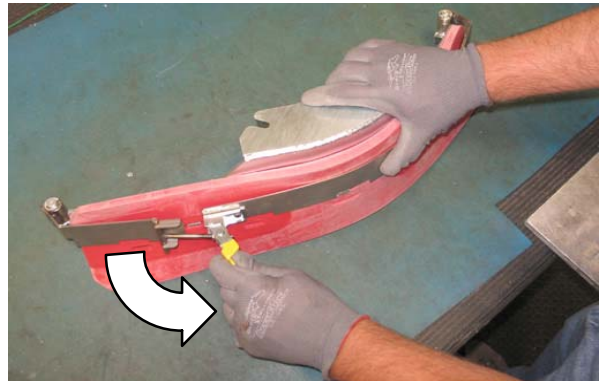

- 5. Remove the squeegee blades and retainer from the squeegee frame.



NOTE: Observe which squeegee slots were installed on the squeegee frame before removing the squeegee.

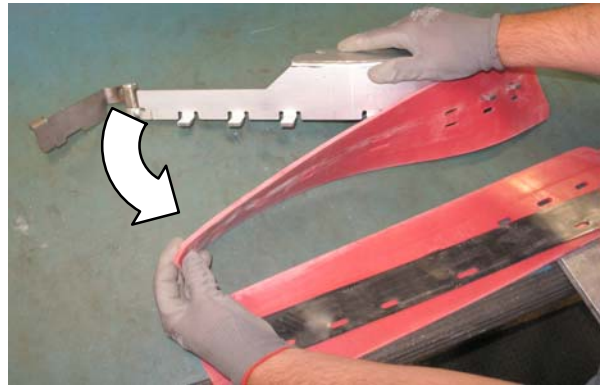

NOTE: The squeegee blade(s) have two sets of slots for adjusting the squeegee blade deflection. Install / reinstall squeegees so the deflection is approximately 12 mm (0.50 in) for smooth floors and 15 mm (0.62 in) for rough floors.

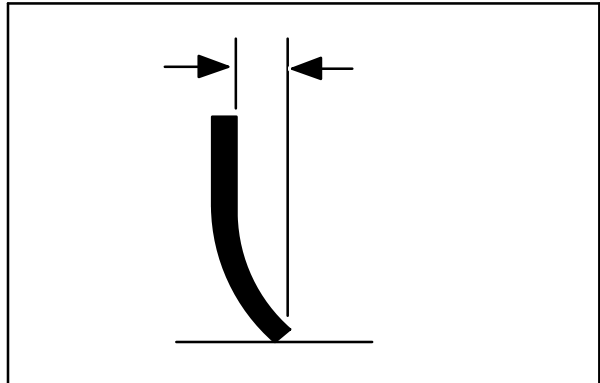

MAINTENANCE

6. Install the rotated / new squeegee blades and retainer onto the side brush assembly.



7. Fasten the side brush retaining band latch.

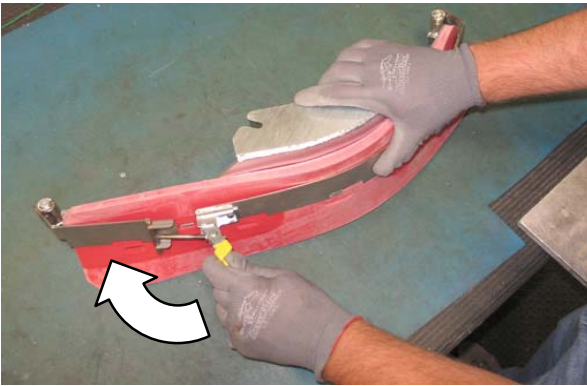

8. Reinstall the side brush squeegee assembly onto the side brush assembly.

SKIRTS AND SEALS

FOR SAFETY: Before leaving or servicing machine, stop on level surface, turn off machine, and remove key.

PRE-SWEEP SIDE SKIRTS (OPTION)

The side skirts are located on both sides of the Pre-Sweep assembly. The side skirts should be just touching the floor.



Check the skirts for damage and wear after every 50 hours of operation.

PRE-SWEEP RECIRCULATION SKIRT (OPTION)

The Pre-Sweep recirculation skirt is located behind the main sweeping brush.



Check the skirt for damage and wear after every 50 hours of operation.

PRE-SWEEP REAR SKIRT (OPTION)

The Pre-Sweep rear skirt is located behind the recirculation skirt and main sweeping brush.

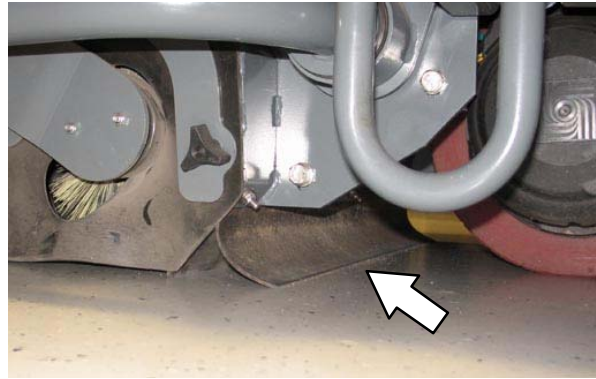

Check the skirt for damage and wear after every 50 hours of operation.

BELTS

FOR SAFETY: Before leaving or servicing machine, stop on level surface, turn off machine, and remove key.

CYLINDRICAL BRUSH DRIVE BELTS

The brush drive belts are located on the cylindrical brush scrub head. Check the belts for damage and wear after every 200 hours of operation.

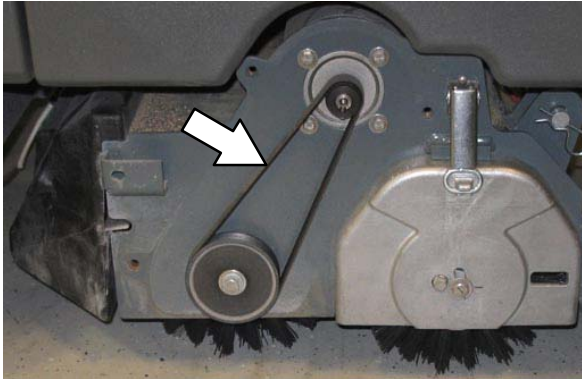

PRE-SWEEP BRUSH DRIVE BELT (OPTION)

The Pre-Sweep brush drive belt is located inside the Pre-Sweep assembly on the right side of the cylindrical brush. Check the belt for damage and wear after every 200 hours of operation.

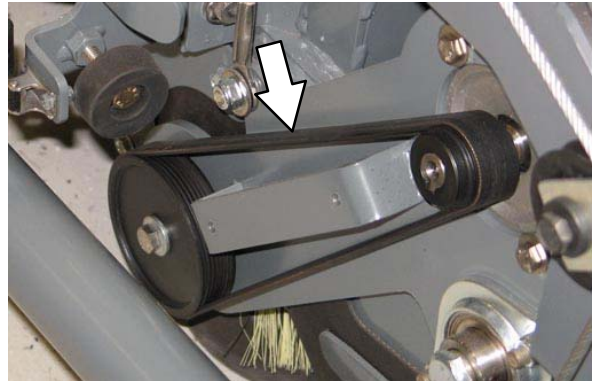

TIRES

FOR SAFETY: Before leaving or servicing machine, stop on level surface, turn off machine, and remove key.

The machine has three solid rubber tires: one in front, and two in the rear of the machine. Check tires for damage and wear after every 500 hours of operation.



PUSHING, TOWING, AND TRANSPORTING THE MACHINE

PUSHING OR TOWING THE MACHINE

If the machine becomes disabled, it can be pushed or towed from the front or rear.

The parking brake must be disabled before towing or pushing the machine. To disable the brake, insert the tip of a small screw driver between the electronic brake lever and the hub. The machine can move freely when the parking brake is disabled.



Only push or tow the machine for a *very short distance* and do not exceed 3.2 kp/h (2 mph). It is NOT intended to be pushed or towed for a long distance or at a high speed.

ATTENTION! Do not push or tow machine for a long distance or damage may occur to the propelling system.

Immediately after pushing the machine, remove the screw driver from between the electronic brake lever and the hub. NEVER operate the machine with the parking brake disabled.

FOR SAFETY: Do not operate machine with brake disabled.

TRANSPORTING THE MACHINE

1. Raise the squeegee, scrub head, and brushes.

FOR SAFETY: When loading/unloading machine onto/off truck or trailer, drain tanks before loading machine.

2. Position the machine at the loading edge of the truck or trailer.

3. If the loading surface is not horizontal or is higher than 380 mm (15 in) from the ground, use a winch to load machine.

If the loading surface is horizontal AND is 380 mm (15 in) or less from the ground, the machine may be driven onto the truck or trailer.

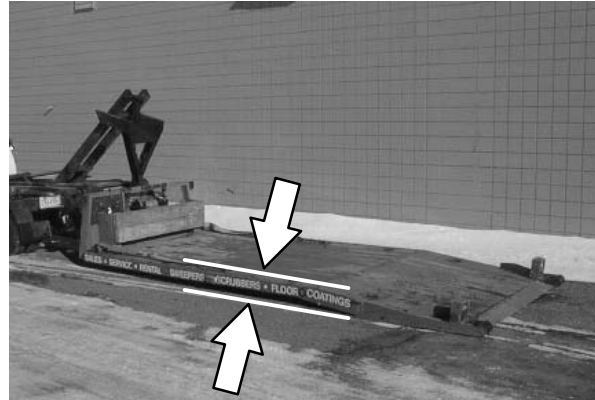

FOR SAFETY: When loading machine onto truck or trailer, use winch. Do not drive the machine onto the truck or trailer unless the loading surface is horizontal AND is 380 mm (15 in) or less from the ground.

4. To winch the machine onto the truck or trailer, attach the winching chains to the stabilizer legs.



5. Position the machine onto the truck or trailer as far as possible. If the machine starts to veer off the center line of the truck or trailer, stop and turn the steering wheel to center the machine.

MAINTENANCE

6. Lower the scrub head and block the machine tires. Tie down the machine to the truck or trailer before transporting.

FOR SAFETY: When loading/unloading machine onto/off truck or trailer, lower scrub head and squeegee before tying down machine.

The front tie-down locations are the stabilizer legs.

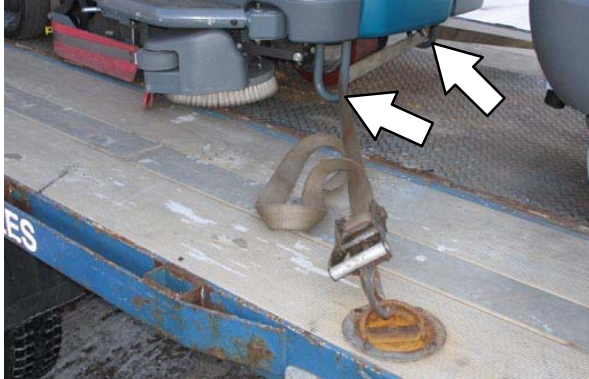

The rear tie-down locations are the holes in the frame.

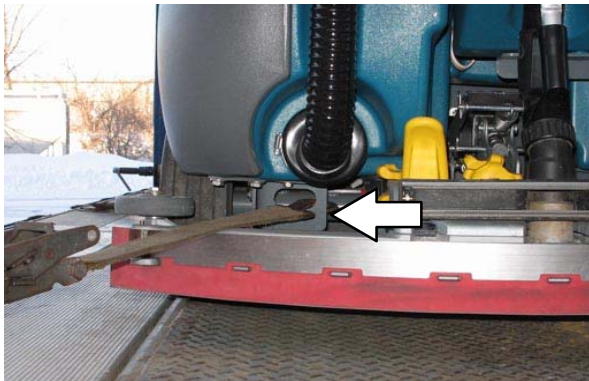

7. If the loading surface is not horizontal or is higher than 380 mm (15 in) from the ground, use a winch to unload machine.

If the loading surface is horizontal AND is 380 mm (15 in) or less from the ground, the machine may be driven off the truck or trailer.

FOR SAFETY: When unloading machine off truck or trailer, use winch. Do not drive the machine off the truck or trailer unless the loading surface is horizontal AND 380 mm (15 in) or less from the ground.

MACHINE JACKING

FOR SAFETY: Before leaving or servicing machine, stop on level surface, turn off machine, and remove key.

Empty the recovery and solution tanks before jacking the machine.

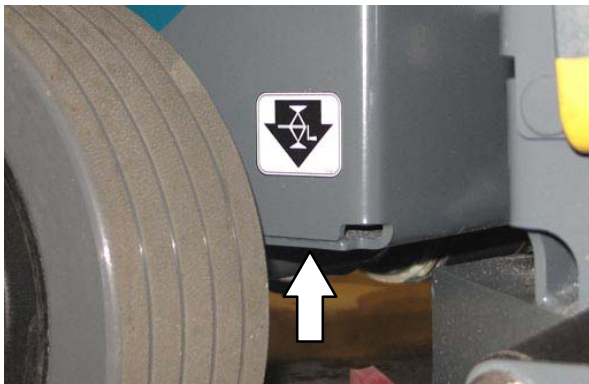
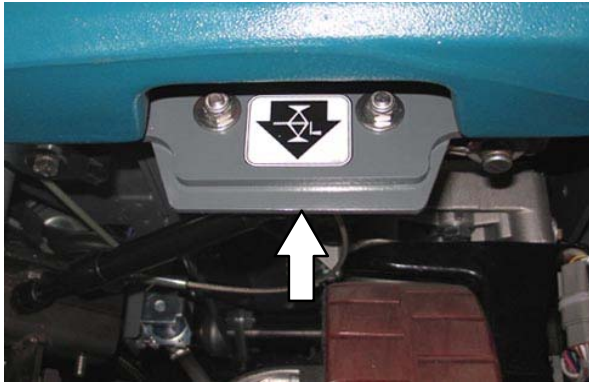

FOR SAFETY: When servicing machine, block machine tires before jacking machine up. Use a hoist or jack that will support the weight of the machine. Jack machine up at designated locations only. Support machine with jack stands.

STORAGE INFORMATION

The following steps should be taken when storing the machine for extended periods of time.

1. Charge the batteries before storing machine to prolong the life of the batteries. Recharge batteries once a month.
2. Disconnect batteries before storing.
3. Thoroughly drain and rinse the solution and recovery tanks.
4. Store the machine in a dry area with the squeegee and scrub head in the up position.

ATTENTION: Do not expose machine to rain, store indoors.

5. Open the recovery tank cover to promote air circulation.
6. If storing machine in freezing temperatures, proceed to *FREEZE PROTECTION*.

NOTE: To prevent potential machine damage store machine in a rodent and insect free environment.

MAINTENANCE

FREEZE PROTECTION (MACHINES WITHOUT OPTIONAL ec-H2O SYSTEM)

FOR SAFETY: Before leaving or servicing machine, stop on level surface and turn off machine.

1. Machines equipped with FaST: Remove the FaST-PAK.
2. Completely drain the solution tank and recovery tank.
3. Disconnect the hose from the solenoid valve inlet port located on the bottom of the frame and allow all remaining solution to drain from the system.

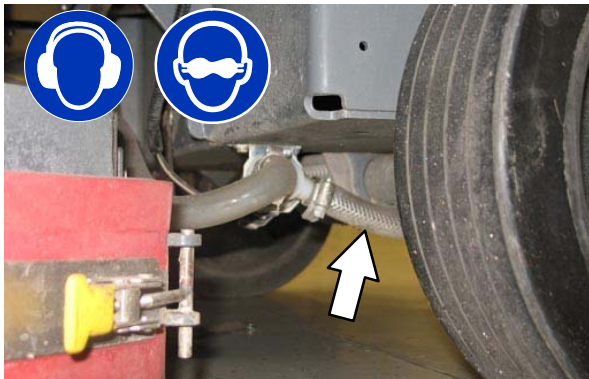

4. Use between 13.8 – 27.6 kPa (2 – 4 psi) of compressed air to blow remaining solution from the disconnected hose.
5. Reconnect the hose to the solenoid valve inlet port.
6. Pour 7.6 L (2 gal) of Propylene Glycol Based / Recreational Vehicle (RV) antifreeze into the solution tank.



7. Turn on the machine
8. Press the *1-STEP* button.

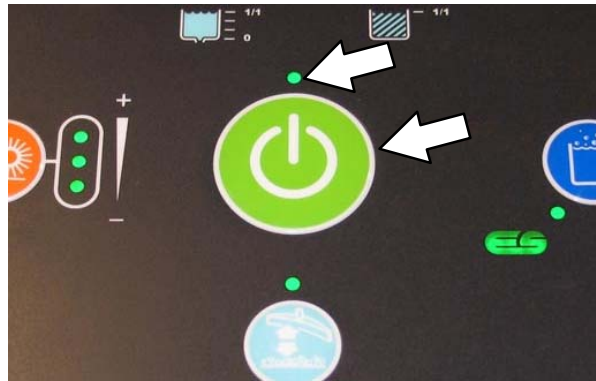

9. Repeatedly press the *Solution increase* button (+) until the solution flow is at the highest setting.



10. Drive the machine to circulate the RV antifreeze completely through the system.
11. Press the *1-STEP* button to turn off the system.
12. **Machines equipped with the optional spray nozzle only:** Operate the wand for a few seconds to protect the pump.
13. Turn off the machine.
14. The remaining RV antifreeze does not need to be drained from the solution tank.

PREPARING THE MACHINE FOR OPERATION (MACHINES WITHOUT OPTIONAL ec-H2O SYSTEM)

All Propylene Glycol Based / Recreational Vehicle (RV) Antifreeze must be completely cleaned from the scrubbing system before the machine can be used for scrubbing.

FOR SAFETY: Before leaving or servicing machine, stop on level surface and turn off machine.

1. Completely drain all Propylene Glycol Based / Recreational Vehicle (RV) antifreeze from the solution tank.
2. Rinse out the solution tank. Refer to *DRAINING AND CLEANING THE SOLUTION TANK* in the *OPERATION* section for instructions how to clean the solution tank.
3. Pour 11.4 L (3 gal) of cool clean water into the solution tank.



4. Turn on the machine
5. Press the *1-STEP* button.



6. Repeatedly press the *Solution increase* button (+) until the solution flow is at the highest setting.



7. Drive the machine to circulate the clean water completely through the system to clean out the RV antifreeze.
8. Press the *1-STEP* button to turn off the system.
9. **Machines equipped with the optional spray nozzle only:** Operate the wand for a few seconds to clean the RV antifreeze from the pump.
10. Turn off the machine.
11. The remaining water does not need to be drained from the solution tank.

MAINTENANCE

FREEZE PROTECTION (MACHINES WITH OPTIONAL ec-H₂O SYSTEM)

1. Completely drain the solution tank and recovery tank.
2. Disconnect the hose from the solenoid valve inlet port located on the bottom of the frame and allow all remaining solution to drain from the system.

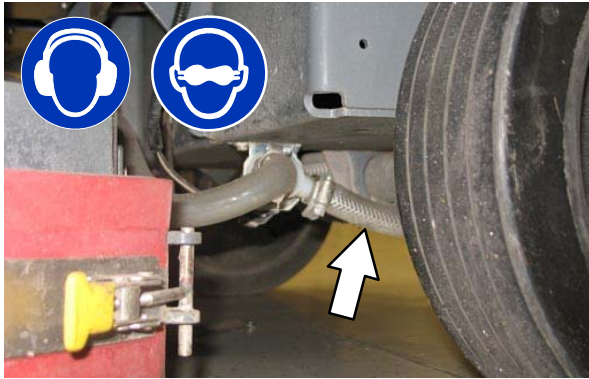

3. Use between 13.8 – 27.6 kPa (2 – 4 psi) of compressed air to blow remaining solution from the disconnected hose.
4. Reconnect the hose to the solenoid valve inlet port.
5. Lift the operator seat open and engage the seat support bar.
6. Remove the ec-H₂O compartment cover.

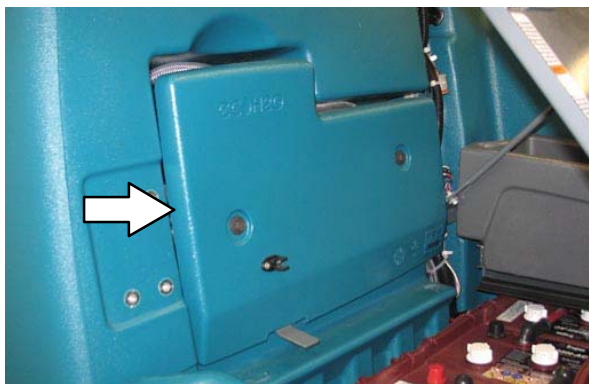

7. Remove the drain hose from the ec-H₂O compartment.

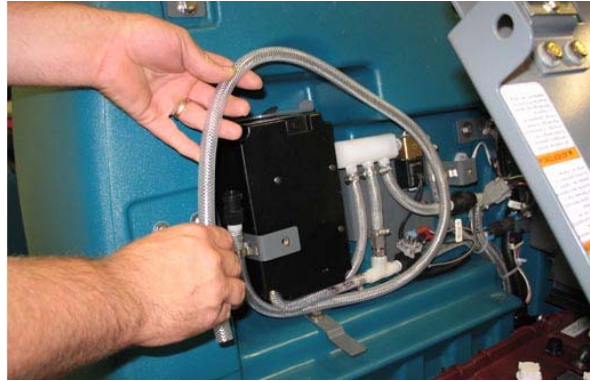

8. Disconnect the outlet hose to the scrub head from the ec-H₂O manifold hose.

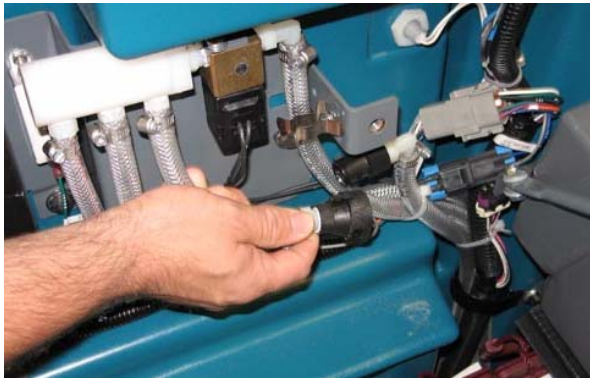

9. Connect the drain hose to the ec-H₂O manifold hose disconnected from the outlet hose in the previous step.



10. Pour 7.6 L (2 gal) of Propylene Glycol Based / Recreational Vehicle (RV) antifreeze into the solution tank.



11. Place the *ec-H2O* system outlet hose into an empty container.
12. Press and release the flush switch on the *ec-H2O* module to cycle the RV antifreeze through *ec-H2O* system. When the antifreeze appears in the container, press the switch again to turn off the module.

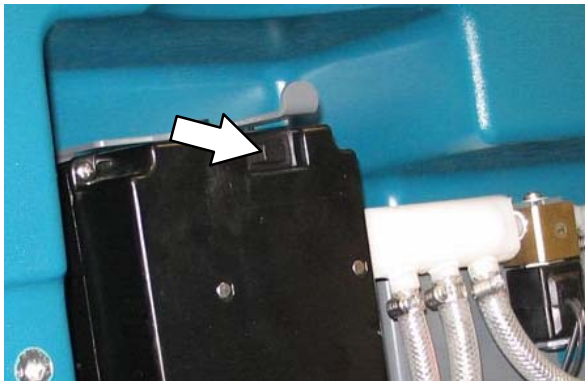

13. Disconnect the drain hose from the *ec-H2O* manifold hose.
14. Reconnect the outlet hose to the scrub head to the *ec-H2O* manifold hose.
15. Place the drain hose back into the *ec-H2O* compartment.
16. Reinstall the *ec-H2O* compartment cover.
17. Close the operator seat cover.

MAINTENANCE

PRIMING THE *ec-H2O* SYSTEM

Prime the *ec-H2O* system if the machine has been stored for a long period with no water in the solution tank / *ec-H2O* system.

FOR SAFETY: Before leaving or servicing machine, stop on level surface and turn off machine.

1. Fill the solution tank with clean cool water. See *FILLING THE SOLUTION TANK* section of this manual.



2. Remove the *ec-H2O* compartment cover.

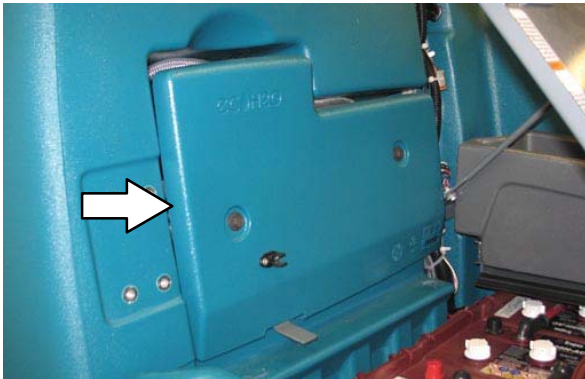

3. Remove the drain hose from the *ec-H2O* compartment.

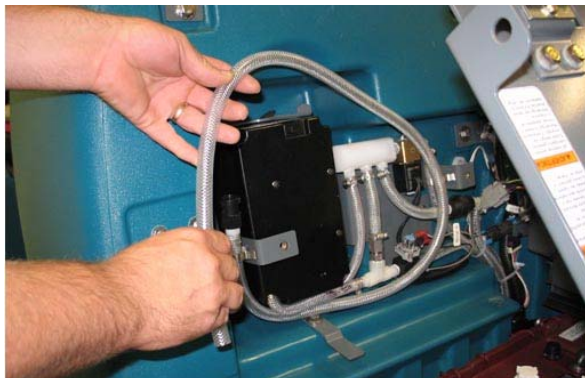

4. Disconnect the outlet hose to the scrub head from the *ec-H2O* manifold hose.

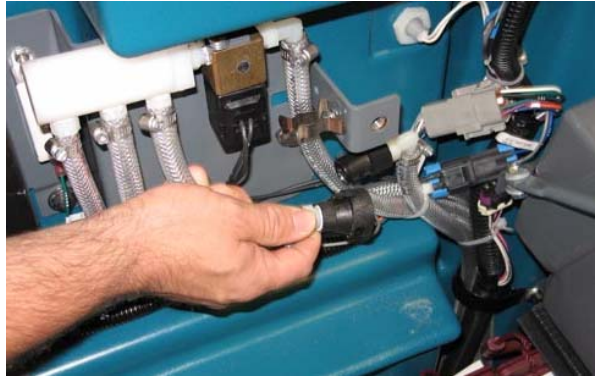

5. Place the drain hose into an empty container.

6. Turn on the machine.

7. Press and release the *ec-H2O* module flush switch. Allow the system to drain water into the container for 2 minutes.

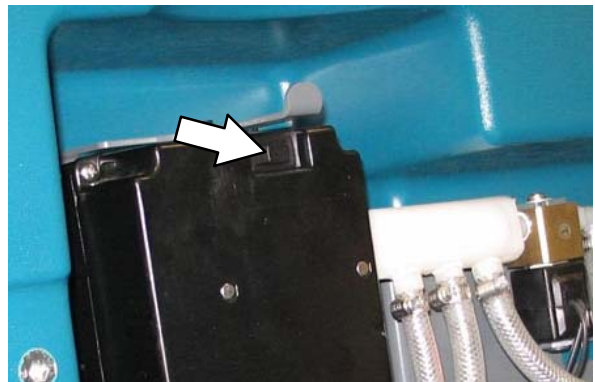

8. Press the *ec-H2O* module flush switch to shut off the system.

9. Disconnect the drain hose from the *ec-H2O* manifold hose.

10. Reconnect the outlet hose to the scrub head to *ec-H2O* manifold hose.

11. Place the drain hose back into the *ec-H2O* compartment.

12. Reinstall the *ec-H2O* compartment cover.

13. Close the operator seat cover.

SPECIFICATIONS

GENERAL MACHINE DIMENSIONS/CAPACITIES

Item	Dimension/capacity
Length	1880 mm (74 in)
Length (with Pre-Sweep)	2510 mm (99 in)
Width (less squeegee)	1040 mm (41 in)
Width (with squeegee)	1070 mm (42 in)
Width (with side brush)	1170 mm (46 in)
Height	1475 mm (58 in)
Height with overhead guard	2080 mm (82 in)
Disk brush diameter for side brush (option)	330 mm (13 in)
Disk brush diameter for Pre-Sweep (option)	460 mm (18 in)
Disk brush diameter	460 mm (18 in)
Cylindrical sweep brush diameter for Pre-Sweep (option)	200 mm (8 in)
Cylindrical sweep brush length for Pre-Sweep (option)	610 mm (24 in)
Cylindrical scrub brush diameter	205 mm (8 in)
Cylindrical brush length	910 mm (36 in)
Scrubbing path width	910 mm (36 in)
Solution tank capacity	190 L (50 gallons)
Solution tank capacity (with optional ES system)	280 L (75 gallons)
Recovery tank capacity	225 L (60 gallons)
Weight (Empty)	500 Kg (1100 lbs)
Weight (with standard 235 AH batteries)	860 Kg (1900 lbs)
GVWR	1270 Kg (2800 lbs)
Protection Grade	IPX3

Values determined as per IEC 60335-2-72	Measure – Cylindrical scrub head	Measure – Disk scrub head
Sound pressure level L_{pA}	62 dB(A)	62 dB(A)
Sound uncertainty K_{pA}	4 dB(A)	3 dB(A)
Sound power level L_{WA} + Uncertainty K_{WA}	89 dB(A)	89 dB(A)
Vibration – Hand–arm	<2.50 m/s ²	<2.50 m/s ²
Vibration – Whole body	<0.50 m/s ²	<0.50 m/s ²

SPECIFICATIONS

GENERAL MACHINE PERFORMANCE

Item	Measure
Aisle turnaround width	2110 mm (83 in)
Aisle turnaround width (with Pre-Sweep)	2620 mm (103 in)
Travel Speed (Forward)	9 Km (5.6 mph)
Travel Speed (Reverse)	4 Km (2.5 mph)
Maximum ramp incline for loading – Empty	19%
Maximum ramp incline for scrubbing	7%
Maximum ramp incline for transporting (GVWR)	14%
Maximum ambient temperature for machine operation	43° C (110° F)
Minimum temperature for operating machine scrubbing functions	0° C (32° F)

POWER TYPE

Type	Quantity	Volts	Ah Rating	Weight
Batteries	6	36	235 @ 20 hr rate	30 kg (67 lb)
	6	36	360 @ 20 hr rate	44 kg (98 lb)

Type	Use	VDC	kW (hp)
Electric Motors	Pre-Sweep brush (disk)	36	0.20 (0.25)
	Pre-Sweep brush (cyl)	36	0.45 (0.60)
	Scrub brush (disk)	36	0.75 (1.00)
	Scrub brush (cylindrical)	36	0.75 (1.00)
	Vacuum fan	36	0.6 (0.8)
	Propelling	36	1.1 (1.5)

Type	VDC	amp	Hz	Phase	VAC
Chargers (Smart)	36	21	45–65	1	85–265

TIRES

Location	Type	Size
Front (1)	Solid	102 mm wide x 300 mm OD (4 in wide x 12 in OD)
Rear (2)	Solid	102 mm wide x 300 mm OD (4 in wide x 12 in OD)

FaST SYSTEM (OPTION)

Item	Measure
Solution pump	36 Volt DC, 1.75A, 4.7 LPM (1.25 GPM) open flow
Solution flow rate (at main brushes)	1.1 LPM (0.30 GPM)
Solution flow rate (at side brush – if machine is equipped with optional side brush)	0.49 LPM (0.13 GPM)
Detergent flow rate (at main brushes)	1.14 CC/Minute (0.038 Ounces/Minute)
Detergent flow rate (at side brush – if machine is equipped with optional side brush)	0.47 CC/Minute (0.016 Ounces/Minute)

ec-H2O SYSTEM (OPTION)

Item	Measure
Solution pump	36 Volt DC, 5A, 6.8 LPM (1.8 GPM) open flow
Solution flow rate (machines without optional side brush)	2.35 LPM (0.62 GPM)
Solution flow rate (machines with optional side brush)	2.84 LPM (0.75 GPM) – (To main scrub head)
	0.95 LPM (0.25 GPM) – (To side brush)

SIDE BRUSH SOLUTION FLOW RATE (OPTION)

Item	Measure
Solution pump	36 Volt DC, 0.33A, 58.7 LPH (15.5 GPH) open flow

MACHINE DIMENSIONS

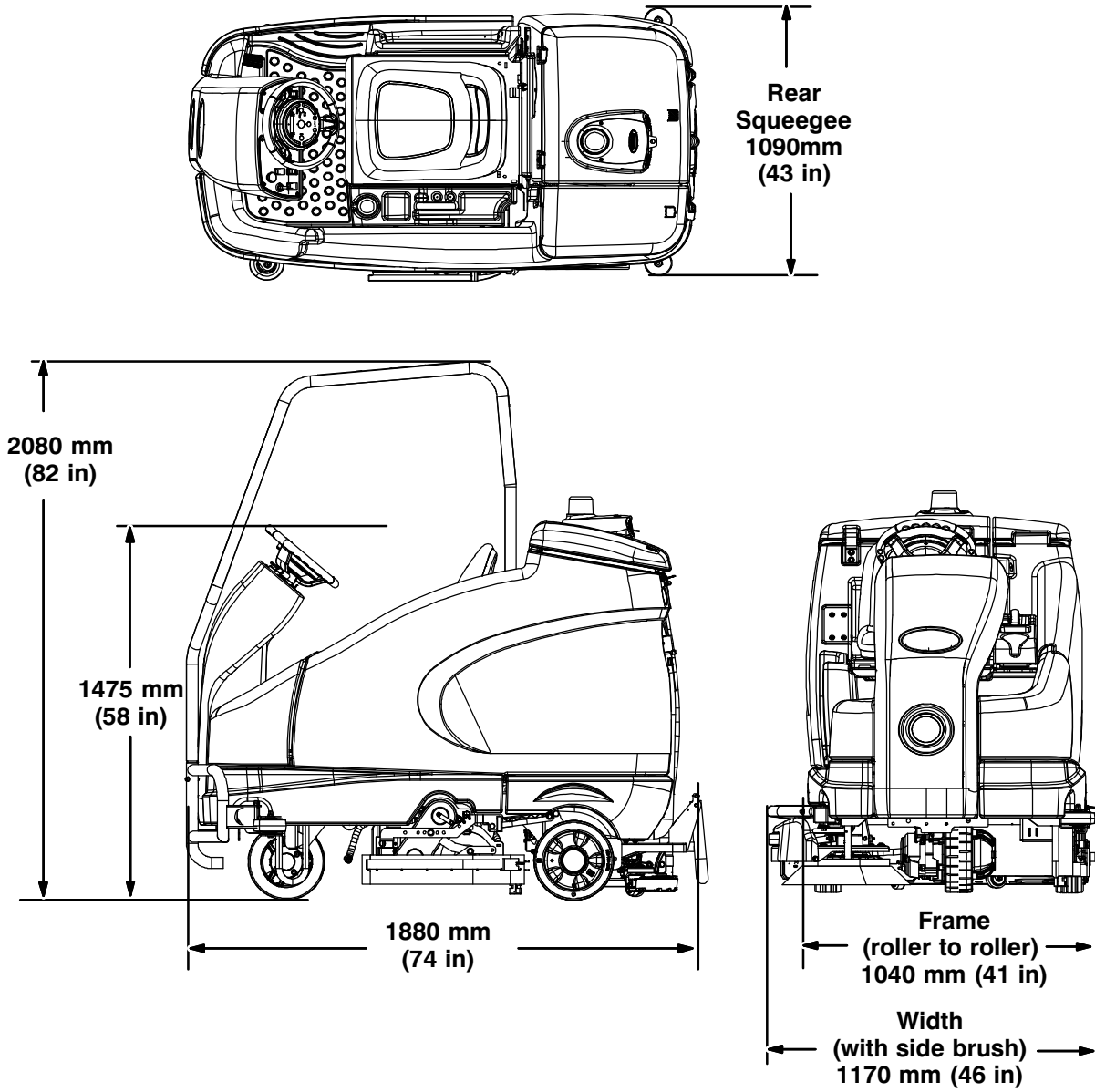

1

- 1–STEP button, 24
- 1–STEP Scrub button, 16, 23, 25, 26

A

- Adjust deluxe suspension seat, 13
- Adjust operator seat, 13
- Adjusting the Rear Squeegee Blade Deflection, 70
- Alarms, 31
 - Fault Indicators, 31

B

- Batteries, 46
 - Changing on–board battery charger fuse, 51
 - Charging batteries (off–board charger), 47
 - Charging batteries (on–board charger), 48
 - Checking connections / cleaning, 46
 - Checking the electrolyte level, 46
 - Flow–Rite battery watering system (option), 52
 - Hydrolink Battery Watering System (option), 54
 - Maintenance, 46
 - On–board battery charger error codes, 49
 - On–board battery charger settings, 50
 - Rollout Battery, 37
- Battery discharge indicator, 10, 11
- Belts, 76
 - Cylindrical brush drive belt, 76
- Belts and Chains
 - Cylindrical brush drive belt, 76
 - Pre–Sweep brush drive belt (option), 76
- Brake pedal, 14
- Brush and Pad Information, 17
- Brush Information, 17
- Brush pressure button, 23
- Buttons
 - 1–STEP button, 24
 - Brush pressure button, 23
 - Configuration mode button, 14
 - Contrast control button, 14
 - Scrub mode button, 23
 - Solution decrease button, 23
 - Solution increase button, 23
 - Solution on / off buttons, 15
 - Vacuum fan / squeegee, 15, 23
 - Vacuum fan/squeegee button, 25, 26

C

- Capacities, 85

- Changing on–board battery charger fuse, 51
- Circuit breakers, 56
- Cleaning the FaST Injector Filters, 63
- Cleaning the FaST Supply Hose Connector, 63
- Configuration mode button, 14
- Contents, 1
- Contrast control button, 14
- Controls
 - 1–STEP button, 24
 - Brush pressure button, 23
 - Circuit breakers, 56
 - Directional switch, 14
 - Key switch, 20
 - Operating / hazard light switch (Option), 12
 - Power shutdown switch, 12
 - Pre–Sweep switch (option), 33
 - Scrub mode button, 15, 23
 - Side brush switch (option), 33
 - Solution decrease button, 23
 - Solution increase button, 23
 - Solution on / off buttons, 15
 - Spray nozzle switch (option), 39
 - Vacuum fan / squeegee button, 23
- Controls and Instruments, 7, 8
 - Touch Panel, 8
- Cylindrical brushes, Replacing brushes, 59

D

- Debris trough, 28
- Dimensions, 85
- Directional switch, 14
- Disable the parking brake, 77
- Disk Brush, Replacing, 57
- Disk brushes, 57 – 62
- Disk Pads, Replace, 58
- Disk Scrub Brushes, Replacing, 57
- Disk Scrub Pads, Replace, 58
- Double Scrubbing, 25
- Draining and Cleaning the Recovery Tank, 27
- Draining and Cleaning the Solution Tank, 29

E

- ec–H2O Scrubbing System, Indicator Light Codes, 24
- ec–H2O Scrubbing System Indicator Light Codes , 24
- ec–H2O System, Specifications, 87

ec–H2O Module Flush Procedure, 64
Electric motors, 56
Electrical system
 Batteries, 46
 Checking connections / cleaning, 46
 Checking the electrolyte level, 46
 Changing on–board battery charger fuse, 51
 Charging batteries (off–board charger), 47
 Charging batteries (on–board charger), 48
 Circuit breakers, 56
 Electric motors, 56
 On–board battery charger settings, 50
Engine, Specifications, 86
Error codes, On–board battery charger, 49

F

FaST System, 63
 Cleaning the FaST Injector Filters, 63
 Cleaning the FaST Supply Hose Connector, 63
 Replacing the FaST–PAK Carton, 63
 Specifications, 87
Fault Indicators, 31
Filling the Solution Tank, 20
 Conventional Scrubbing Mode, 21
 ec–H2O scrubbing (ec–H2O Mode), 20
 ES (Extended Scrub) Mode – Manually Filling Tank, 22
 Foam scrubbing (FaST Mode), 20
Flow–Rite battery watering system (option), 52
Flush Procedure, ec–H2O Module, 64
Freeze Protection, 80, 81
Freeze Protection, Machines With ec–H2O System, 82

H

Hour Meter, 11
How the Machine Works, 16
Hydrolink Battery Watering System (option), 54

I

Indicator Light Codes, ec–H2O Scrubbing System, 24
Indicators
 Battery discharge, 10, 11
 Fault Indicators, 31
 Hour Meter, 11
 Recovery tank, 11
 Solution tank, 11
 Warning codes, 32

Installing Batteries, 10

K

Key switch, 20

L

Leveling the Rear Squeegee, 69
Lights, Operating / hazard light switch (Option), 12
Lubrication, 45
 Rear squeegee caster pivot points, 45
 Steering chain, 45
 Steering gear chain, 45

M

Machine components, 6
Machine Dimensions, 88
Machine Jacking, 79
Machine Operation
 Double scrubbing, 25
 Pre–Operation Checklist, 19
 Scrubbing, 24
 Starting the machine, 20
 Stop scrubbing, 26
 Stopping the machine, 30
Machine Performance
 Aisle Turnaround Width, 86
 Climb and Descent Angles, 86
 Travel Speed (Maximum), 86
Machine Specifications, 85 – 88
Machine Troubleshooting, 40
Maintenance, 42 – 66
 Batteries, 46
 Checking connections / cleaning, 46
 Checking the electrolyte level, 46
 Belts, 76
 Charging batteries (off–board charger), 47
 Charging batteries (on–board charger), 48
 Changing on–board battery charger fuse, 51
 Circuit Breakers, 56
 Cylindrical brushes, 59 – 64
 Disk brushes, 57 – 62
 ec–H2O Module, 64
 FaST System, 63
 Lubrication, 45
 Machine Jacking, 79
 On–board battery charger settings, 50
 Pre–Sweep brushes, 61 – 66
 Pre–Sweep rear skirt, 75
 Pre–Sweep recirculation skirt, 75
 Pre–Sweep side skirts (option), 75

Pushing, Towing, and Transporting the Machine, 77
 Replacing cylindrical brushes, 59
 Side Brush (Option), 60
 Skirts and Seals, 75
 Squeegee Blades, 66
 Storage Information, 79
 Tires, 76
 Yellow Touch Points, 45
 Maintenance Chart, 43

O

On-board battery charger error codes, 49 – 54
 Operating / hazard light switch (Option), 12
 Operating temperature, 18
 Operation, 6 – 30
 Operation of controls, 11
 Operator seat, 13
 Options, 33 – 35
 Pre-Sweep, 33
 Pre-Sweep debris hopper, 34
 Rear Squeegee Guard, 38
 Rollout Battery, 37
 Side brush, 33
 Spray Nozzle, 39
 Vacuum wand, 35

P

Pad Driver, Replacing, 57
 Pad Information, 17
 Parking brake, Disable the parking brake, 77
 Pedals
 Brake pedal, 14
 Propel pedal, 14
 Power shutdown switch, 12
 Pre-Operation Checklist, 19
 Pre-Sweep (Option), 33
 Emptying the debris hopper, 34
 Replace vacuum debris bag, 34
 Replacing the Cylindrical Brush, 62
 Replacing the Disk Brush, 61
 Pre-Sweep brushes, 61 – 66
 Pre-Sweep Cylindrical Brush, Replacing, 62
 Pre-Sweep Disk Brush, Replacing, 61
 Priming the ec-H₂O system, 84
 Propel pedal, 14
 Pushing or Towing the Machine, 77

Pushing, Towing, and Transporting the Machine, 77
 Pushing or Towing the Machine, 77
 Transporting the Machine, 77

R

Rear Squeegee
 Adjusting the Rear Squeegee Blade Deflection, 70
 Leveling the Rear Squeegee, 69
 Rear Squeegee Blade, Replacing (or Rotating) the Rear Squeegee Blade, 66
 Rear Squeegee Guard (option), 38
 Rear Squeegee, Replacing (or Rotating), 66
 Recovery tank indicator, 11
 Replacing (or Rotating) the Rear Squeegee Blades, 66
 Replacing or Rotating the Side Brush Squeegee Blade (Option), 72
 Replacing or Rotating the Side Squeegee Blades, 71
 Replacing the FaST-PAK Carton, 63
 Replacing the Pre-Sweep Cylindrical Brush (Option), 62
 Replacing the Pre-Sweep Disk Brush (Option), 61
 Replacing the Side Brush (Option), 60
 Rollout Battery (option), 37

S

Safety
 Labels, 5
 Precautions, 3 – 5
 Scrub brushes
 Cylindrical brushes, 59
 Replacing cylindrical brushes, 59
 Scrub Brushes and Pads, 57
 Disk brushes, 57
 Replacing Disk Brushes or Pad Driver, 57
 Replacing Disk Scrub Pads, 58
 Scrub mode button, 23
 Scrubbing, 24
 Double scrubbing, 25
 Stop scrubbing, 26 – 28
 Seals, 75
 Seat belts, 13
 Seat support arm, 12
 Seat, deluxe suspension, 13

- Seat, Operator, 13
 - Setting Brush Pressure, 23
 - Setting Conventional Solution Flow, 23
 - Setting ES Solution Flow, 23
 - Setting Scrub Modes, 23
 - Setting Brush Pressure, 23
 - Setting ES Solution Flow, 23
 - Setting Solution Flow, 23
 - Conventional Mode, 23
 - ES (Extended Scrub) Mode, 23
 - Side Brush (Option), 33, 60
 - Replacing or Rotating the Side Brush Squeegee, 72
 - Replacing the Side Brush, 60
 - Side Brush Squeegee (Option), Replacing or Rotating, 72
 - Side Brush System, Specifications, 87
 - Side Brush, Replacing, 60
 - Side Squeegee Blades, 71
 - Replacing or Rotating the Side Squeegee Blades, 71
 - Side Squeegee Blades, Replacing or Rotating, 71
 - Skirts and seals, 75
 - Pre-Sweep rear skirt, 75
 - Pre-Sweep recirculation skirt, 75
 - Pre-Sweep side skirts (option), 75
 - Solution decrease button, 23
 - Solution increase button, 23
 - Solution on / off buttons, 15
 - Solution tank indicator, 11
 - Specifications, 85 – 88
 - ec-H2O System, 87
 - FaST System, 87
 - Machine Capacities, 85
 - Machine Dimensions, 85
 - Machine Performance, 86
 - Power Type, 86
 - Side Brush System, 87
 - Tires, 86
 - Spray Nozzle (Option), 39
 - Squeegee Blades, 66
 - Adjusting the Rear Squeegee Blade Deflection, 70
 - Leveling the Rear Squeegee, 69
 - Replacing (or Rotating) the Rear Squeegee Blades, 66
 - Replacing or Rotating the Side Brush Squeegee Blade (Option), 72
 - Replacing or Rotating the Side Squeegee Blades, 71
 - Starting the machine, 20
 - Stopping the machine, 30
 - Storage Information, 79
 - Freeze Protection, Machines With ec-H2O System, 82
 - Freeze Protection, Machines Without ec-H2O System, 80
 - Preparing Machine for Operation, Machines Without ec-H2O System, 81
 - Priming the ec-H2O system, 84
 - Switches
 - Directional switch, 14
 - Key switch, 20
 - Operating / hazard light switch (Option), 12
 - Power shutdown switch, 12
 - Pre-Sweep switch (option), 33
 - Side brush switch (option), 33
 - Spray nozzle switch (option), 39
 - Symbol definitions, 9 – 11
- T**
- Temperature, Operating, 18
 - Tires, 76
 - Specifications, 86
 - Touch Panel, 8
 - Towing the Machine, 77
 - Transporting the Machine, 77
- V**
- Vacuum fan / squeegee button, 15, 23
 - Vacuum wand (option), 35
- W**
- Warning codes, 32
 - Warning Indicators, 11
 - Water Pickup Mode (No Scrubbing), 26
 - Wheels, 76
 - While Operating the Machine, 18
- Y**
- Yellow Touch Points, 45